



SKANDIMĒBELES
SKANDINĀVU DIZAINA MĒBEĻU SALONS

**KONTINENTĀLO GULTU
UN AKSESUĀRU
KATALOGS**

PROXIMA



LOVOS / BEDS

PROXIMA	3
PALERMO	4
LUND	5
NERO	6
SCANDINAVIA	7
DORA	8
PANAMA	9
SORENTO	10
MILA	11
CONTINENTAL	12
TURKU	13
HELSINKI	14
OSAKA	15
VERONA	16
EMKO	17
DENVER	18
CAPI	19
CLOUD	20
SUZZY	21

KUŠETĖS IR KITOS LOVOS / COUCHES AND OTHER BEDS

DOUBLE BED	22
HARMONY	23
EXCLUSIVE	24
TITIKAKA	25

FUNKCINĖS LOVOS / FUNCTIONAL BEDS

MONACO	26
KAMASUTRA	27
NIRVANA	28
OSLO	29
MODENA	30
MILANO	31
SIMPLE ELECTRO	32

Galvūgaliai / Headboards	33
Čiužiniai / Mattresses	37
Higieniniai čiužiniai / Top-mattresses	43
Naktiniai Staliukai / Night stands	48
Pufai / Poufs	50
Kojelės / Legs	51
Pagalvės / Pillows	52
Spyruoklės / Springs	54
Smulkinto porolono granulės / Shredded foam	56
Apie įmonę / About company	57
Katalogo sutartiniai ženklai / Catalog legend	58

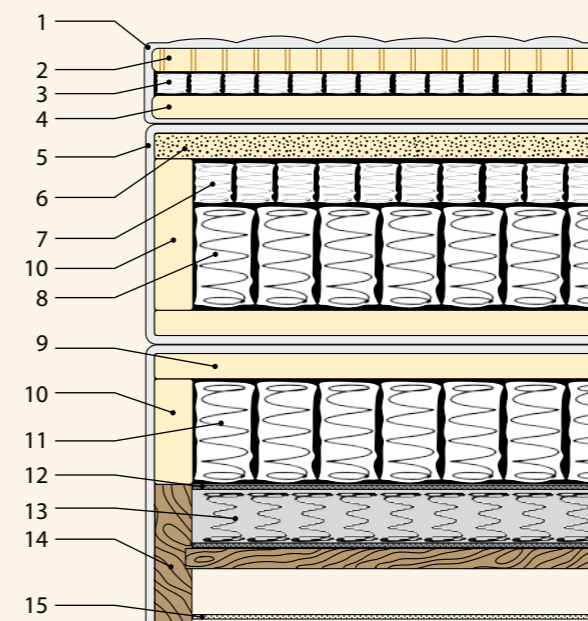

1. Higieninio čiužinio užvalkalas
2. Lateksas, h - 2 cm
3. Mikro kišeninės spyruoklės, h - 3 cm
4. Porolonas T - 30 kg/m³, h - 2 cm
5. Audinys, laminuotas su 3 mm porolonu
6. Didelio elastingumo porolonas, HR - 35 kg/m³, h - 2 cm
7. Mini kišeninės spyruoklės, h - 5 cm
8. 9 minkštumo zonų kišeninės spyruoklės, h - 13 cm
9. Porolonas, T - 25 kg/m³, h - 2 cm
10. Porolonas
11. 5 minkštumo zonų kišeninės spyruoklės, h - 13 cm
12. Neaustinė kaišytinė medžiaga
13. Mini bonnell spyruoklės, h - 11 cm
14. Medinis rėmas, 12x3 cm
15. Neaustinė medžiaga - sponbondas



1. Top - mattress cover
2. Latex, h - 2 cm
3. Micro pocket springs, h - 3 cm
4. Foam T - 30 kg/m³, h - 2 cm
5. Fabric, laminated with 3 mm of foam
6. High - resilience foam, HR - 35 kg/m³, h - 2 cm
7. Mini pocket springs, h - 5 cm
8. 9 firmness zones pocket springs, h - 13 cm
9. Foam T - 25 kg/m³, h - 2 cm
10. Foam
11. 5 firmness zones pocket springs, h - 13 cm
12. Non - woven caulked material
13. Mini Bonnell springs, h - 11 cm
14. Wooden frame, 12x3 cm
15. Non - woven material - sponbondas

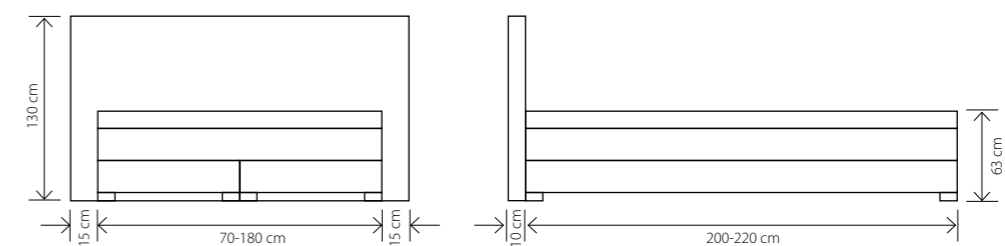

PALERMO

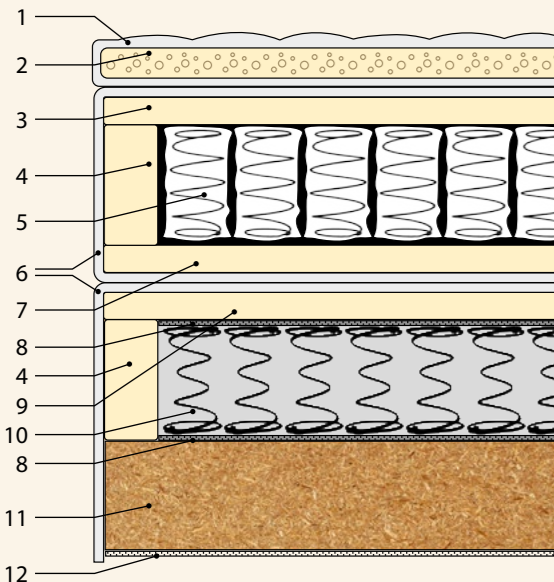

1. Higieninio čiuzinio užvalkalas
2. Viskoelastinis porolonas VE - 57 kg/m³, h - 6 cm
3. Porolonas T - 30 kg/m³, h - 3 cm
4. Porolonas
5. 7 minkštumo zonų kišeninės spyruoklės, h - 13 cm
6. Audinys, laminuotas su 3 mm porolonu
7. Porolonas T - 25 kg/m³, h - 3 cm
8. Neaustinė kaišytinė medžiaga
9. Porolonas T - 25 kg/m³, h - 2 cm
10. Bonnell spyruoklės, h - 11 cm
11. MDP dėžė
12. Neaustinė medžiaga - sponbondas



1. Top - mattress cover
2. Visco foam VE - 57 kg/m³, h - 6 cm
3. Foam T - 30 kg/m³, h - 3 cm
4. Foam
5. 7 firmness zones pocket springs, h - 13 cm
6. Fabric, laminated with 3 mm of foam
7. Foam T - 25 kg/m³, h - 3 cm
8. Non - woven caulked material
9. Foam T - 25 kg/m³, h - 2 cm
10. Bonnell springs, h - 11 cm
11. Chipboard box
12. Non - woven material - sponbond

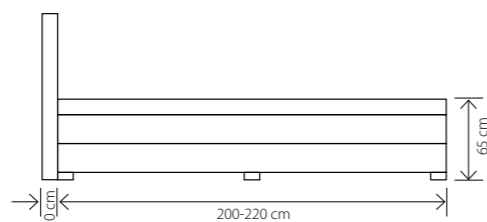
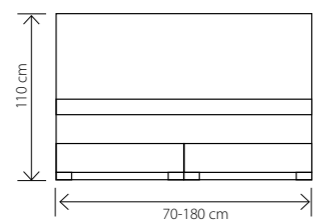

LUND

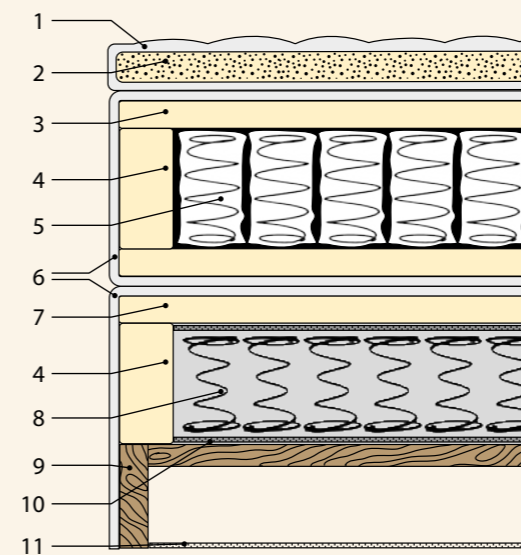

1. Higieninio čiuzinio užvalkalas
2. Didelio elastingumo porolonas HR - 35 kg/m³, h - 3 cm
3. Porolonas T - 30 kg/m³, h - 4 cm
4. Porolonas
5. 5 minkštumo zonų kišeninės spyruoklės, h - 13 cm
6. Audinys, laminuotas su 3 mm porolonu
7. Porolonas T - 30 kg/m³, h - 2 cm
8. Bonnell spyruoklės, h - 12 cm
9. Medinis rėmas 8x4 cm
10. Neaustinė kaišytinė medžiaga
11. Neaustinė medžiaga - sponbondas



1. Top - mattress cover
2. High - resilience foam HR - 35 kg/m³, h - 3 cm
3. Foam T - 30 kg/m³, h - 4 cm
4. Foam
5. 5 firmness zones pocket springs, h - 13 cm
6. Fabric, laminated with 3 mm of foam
7. Foam T - 30 kg/m³, h - 2 cm
8. Bonnell springs, h - 12 cm
9. Wooden frame, 8x4 cm
10. Non - woven caulked material
11. Non - woven material - sponbond

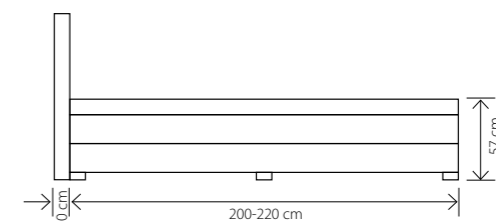
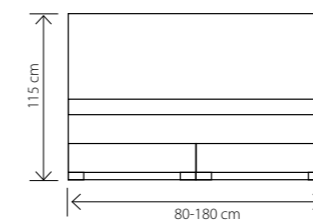

NERO

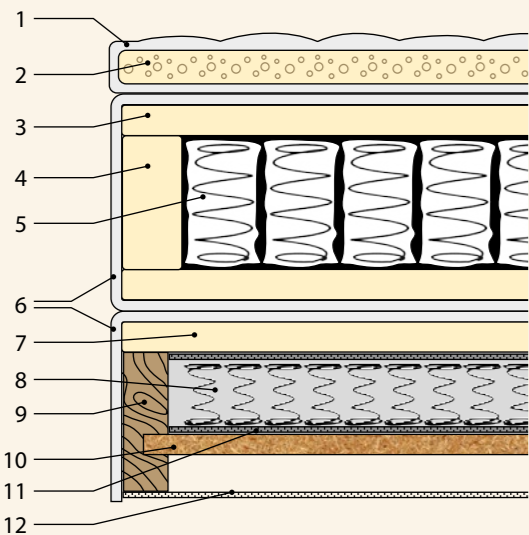

1. Higieninio čiužinio užvalkalas
2. Viskoelastinis porolonas VE - 57 kg/m³, h - 6 cm
3. Porolonas T - 30 kg/m³, h - 3 cm
4. Porolonas
5. 7 minkštumo zonų kišeninės spyruoklės, h - 15 cm
6. Audinys, laminuotas su 3 mm porolonu
7. Porolonas T - 25 kg/m³, h - 2 cm
8. Mini bonnell spyruoklės, h - 7 cm
9. Medinis rėmas, 12x3 cm
10. MDP
11. Neaustinė kaišytinė medžiaga
12. Neaustinė medžiaga - sponbondas



1. Top - mattress cover
2. Visco foam VE - 57 kg/m³, h - 6 cm
3. Foam T - 30 kg/m³, h - 3 cm
4. Foam
5. 7 firmness zones pocket springs, h - 15 cm
6. Fabric, laminated with 3 mm of foam
7. Foam T - 25 kg/m³, h - 2 cm
8. Mini bonnell springs, h - 7 cm
9. Wooden frame, 12x3 cm
10. Chipboard
11. Non - woven caulked material
12. Non - woven material - sponbond

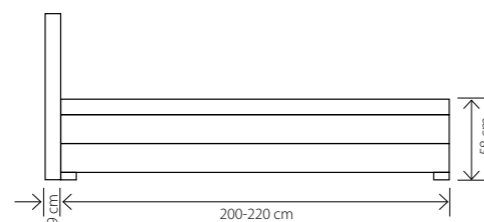
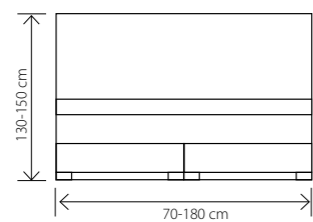

SCANDINAVIA

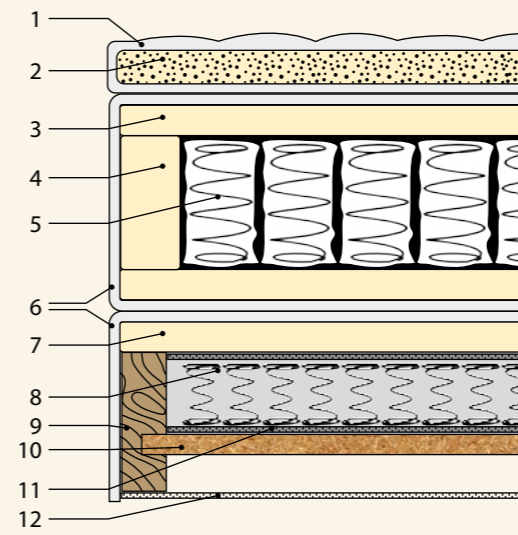

1. Higieninio čiužinio užvalkalas
2. Didelio elastingumo porolonas HR - 35 kg/m³, h - 3 cm
3. Porolonas T - 30 kg/m³, h - 4 cm
4. Porolonas
5. 7 minkštumo zonų kišeninės spyruoklės, h - 15 cm
6. Audinys, laminuotas su 3 mm porolonu
7. Porolonas T - 25 kg/m³, h - 2 cm
8. Mini bonnell spyruoklės, h - 7 cm
9. Medinis rėmas, 12x3 cm
10. MDP
11. Neaustinė kaišytinė medžiaga
12. Neaustinė medžiaga - sponbondas



1. Top - mattress cover
2. High - resilience foam HR - 35 kg/m³, h - 3 cm
3. Foam T - 30 kg/m³, h - 4 cm
4. Foam
5. 7 firmness zones pocket springs, h - 15 cm
6. Fabric, laminated with 3 mm of foam
7. Foam T - 25 kg/m³, h - 2 cm
8. Mini bonnell springs, h - 7 cm
9. Wooden frame, 12x3 cm
10. Chipboard
11. Non - woven caulked material
12. Non - woven material - sponbond

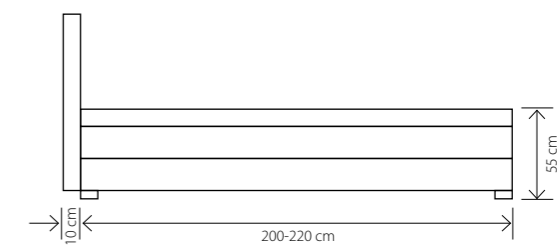
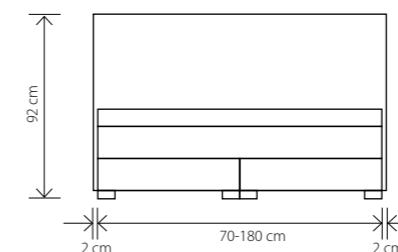

DORA

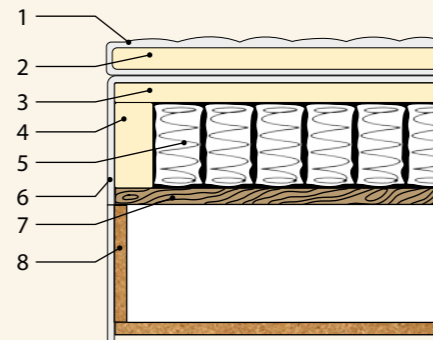
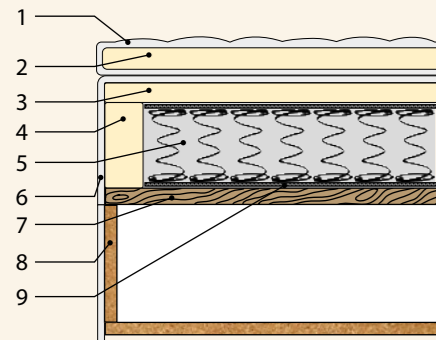

BONNELL



1. Higieninio čiužinio užvalkalas
2. Porolonas T - 25 kg/m³, h - 3 cm
3. Porolonas T - 25 kg/m³, h - 2 cm
4. Porolonas
5. Bonnell spyruoklės, h - 12 cm
6. Audinys, laminuotas su 3 mm porolonu
7. Medinis rėmas, 4x4 cm
8. LMDP dėžė patalynei
9. Neaustinė kaišytinė medžiaga



1. Top - mattress cover
2. Foam T - 25 kg/m³, h - 3 cm
3. Foam T - 25 kg/m³, h - 2 cm
4. Foam
5. Bonnell springs, h-12 cm
6. Fabric, laminated with 3 mm of foam
7. Wooden frame, 4x4 cm
8. Laminated chipboard box
9. Non - woven caulked material

POCKET



1. Higieninio čiužinio užvalkalas
2. Porolonas T - 25 kg/m³, h - 3 cm
3. Porolonas T - 25 kg/m³, h - 2 cm
4. Porolonas
5. 5 minkštumo zonų kišeninės spyruoklės, h - 13 cm
6. Audinys, laminuotas su 3 mm porolonu
7. Medinis rėmas, 4x4 cm
8. LMDP dėžė patalynei



1. Top - mattress cover
2. Foam T - 25 kg/m³, h - 3 cm
3. Foam T - 25 kg/m³, h - 2 cm
4. Foam
5. 5 firmness zones pocket springs, h - 13 cm
6. Fabric, laminated with 3 mm of foam
7. Wooden frame, 4x4 cm
8. Laminated chipboard box

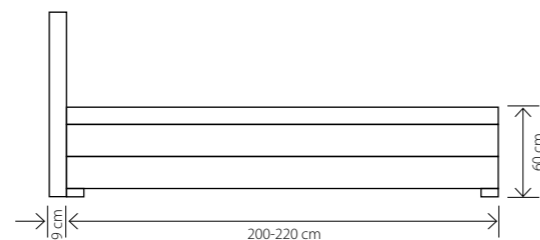
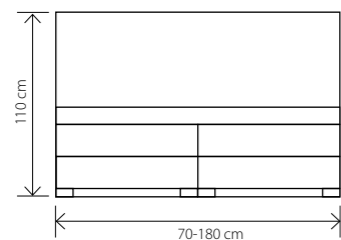

PANAMA



1. Higieninio čiužinio užvalkalas
2. Didelio elastingumo porolonas HR - 35 kg/m³, h - 3 cm
3. Porolonas T - 25 kg/m³, h - 2 cm
4. Porolonas
5. 5 minkštumo zonų kišeninės spyruoklės, h - 13 cm
6. Audinys, laminuotas su 3 mm porolonu
7. Medinis rėmas, 4x4 cm
8. LMDP patalynės dėžė
9. MDP
10. Porolonas T - 25 kg/m³, h - 2 cm
11. Bonnell spyruoklės, h - 12 cm
12. Medinis rėmas, 8x4 cm
13. Neaustinė kaišytinė medžiaga
14. Neaustinė medžiaga - sponbondas
15. Ištraukiamas stalčius

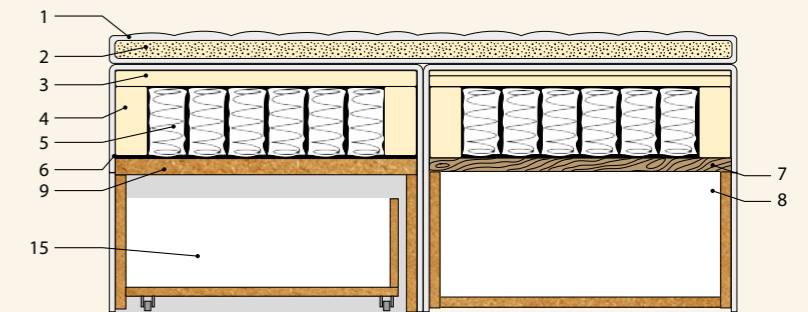

1. Top - mattress cover
2. High -resilience foam HR - 35 kg/m³, h - 3 cm
3. Foam T - 25 kg/m³, h - 2 cm
4. Foam
5. 5 firmness zones pocket springs, h - 13 cm
6. Fabric, laminated with 3 mm of foam
7. Wooden frame, 4x4 cm
8. Laminated chipboard box
9. Chipboard
10. Foam T - 25 kg/m³, h - 2 cm
11. Bonnell springs, h - 12 cm
12. Wooden frame, 8x4 cm
13. Non - woven caulked material
14. Non - woven material - sponbond
15. Laminated chipboard drawer

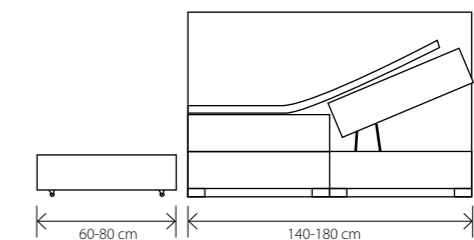
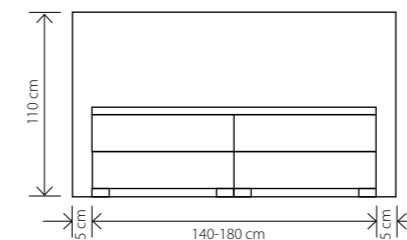
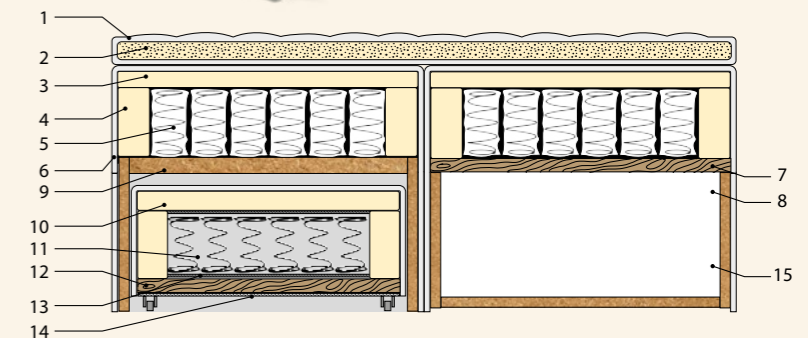

SORENTO

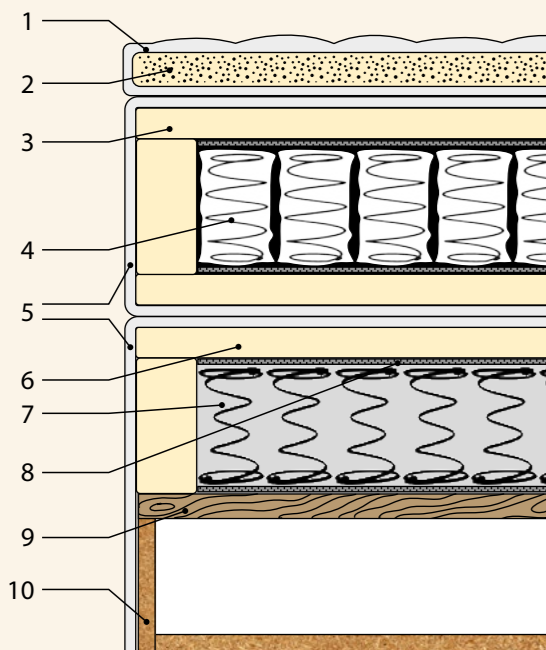

1. Higieninio čiužinio užvalkalas
2. Didelio elastingumo porolonas HR - 35 kg/m³, h - 4 cm
3. Porolonas T - 25 kg/m³, h - 2 cm
4. 5 minkštumo zonų kišeninės spyruoklės, h - 13 cm
5. Audinys, laminuotas su 3 mm porolonu
6. Porolonas T - 25 kg/m³, h - 1 cm
7. Bonnell spyruoklės, h - 11 cm
8. Neaustinė kaišytinė medžiaga
9. Medinis rėmas, 4x4 cm
10. LMDP patalynės dėžė



1. Top - mattress cover
2. High - resilience foam HR - 35 kg/m³, h - 4 cm
3. Foam T - 25 kg/m³, h - 2 cm
4. 5 firmness zones pocket springs, h - 13 cm
5. Fabric, laminated with 3 mm of foam
6. Foam T - 25 kg/m³, h - 1 cm
7. Bonnell springs, h - 11 cm
8. Non - woven caulked material
9. Wooden frame, 4x4 cm
10. Laminated chipboard box

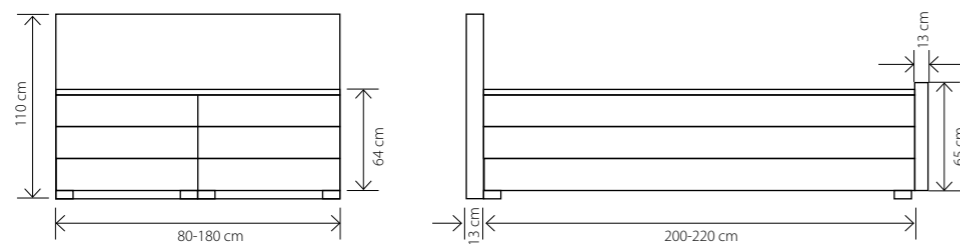

MILA

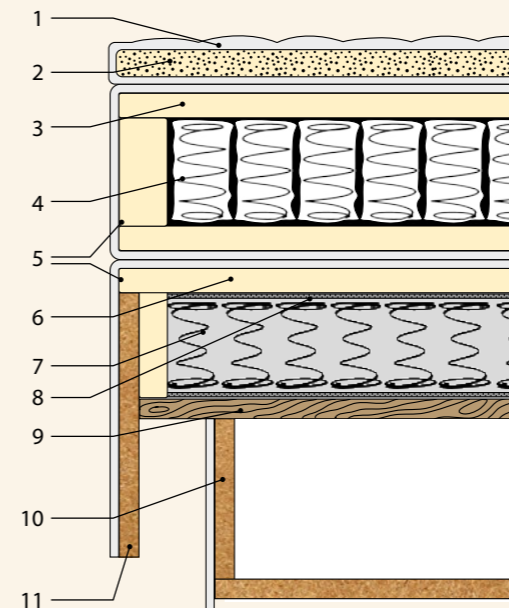

1. Higieninio čiužinio užvalkalas
2. Didelio elastingumo porolonas HR - 35 kg/m³, h - 6 cm
3. Porolonas T - 30 kg/m³, h - 2 cm
4. 5 minkštumo zonų kišeninės spyruoklės, h - 13 cm
5. Audinys, laminuotas su 3 mm porolonu
6. Porolonas T - 25 kg/m³, h - 1 cm
7. Bonnell spyruoklės, h - 11 cm
8. Neaustinė kaišytinė medžiaga
9. Medinis rėmas, 4x4 cm
10. LMDP patalynės dėžė
11. MPD dėžė



1. Top - mattress cover
2. High - resilience foam HR - 35 kg/m³, h - 6 cm
3. Foam T - 30 kg/m³, h - 2 cm
4. 5 firmness zones pocket springs, h - 13 cm
5. Fabric, laminated with 3 mm of foam
6. Foam T - 25 kg/m³, h - 1 cm
7. Bonnell springs, h - 11 cm
8. Non - woven caulked material
9. Wooden frame, 4x4 cm
10. laminated chipboard box
11. Chipboard box

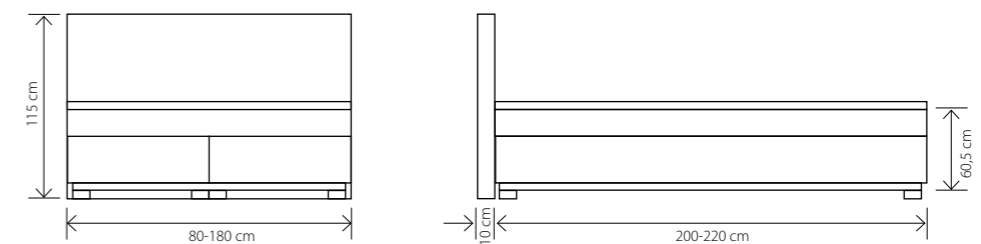

CONTINENTAL

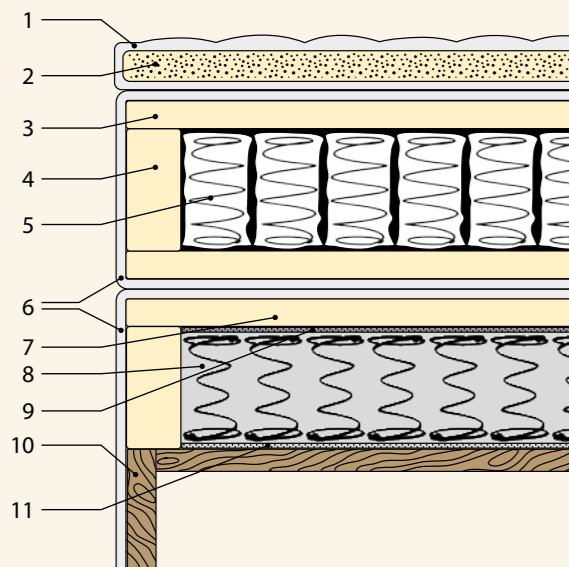

1. Higieninio čiužinio užvalkalas
2. Didelio elastingumo porolonas HR - 35 kg/m³, h - 4 cm
3. Porolonas T - 25 kg/m³, h - 3 cm
4. Porolonas
5. 5 minkštumo zonų kišeninės spyruoklės, h - 13 cm
6. Audinys, laminuotas su 3 mm porolonu
7. Porolonas T - 25 kg/m³, h - 2 cm
8. Bonnell spyruoklės, h - 12 cm
9. Neaustinė kaišytinė medžiaga
10. Medinis rėmas, 12x3 cm
11. Neaustinė medžiaga - sponbondas



1. Top - mattress cover
2. High - resilience foam, HR - 35 kg/m³, h - 4 cm
3. Foam T - 25 kg/m³, h - 3 cm
4. Foam
5. 5 firmness zones pocket springs, h - 13 cm
6. Fabric, laminated with 3 mm of foam
7. Foam T - 25 kg/m³, h - 2 cm
8. Bonnell springs, h - 12 cm
9. Non - woven caulked material
10. Wooden frame, 12x3 cm
11. Non - woven material - sponbond

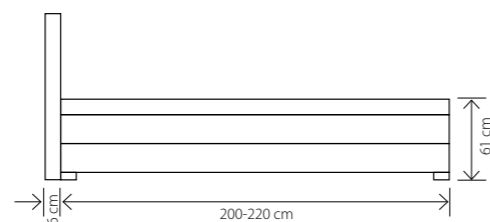
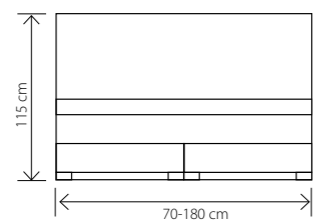

TURKU

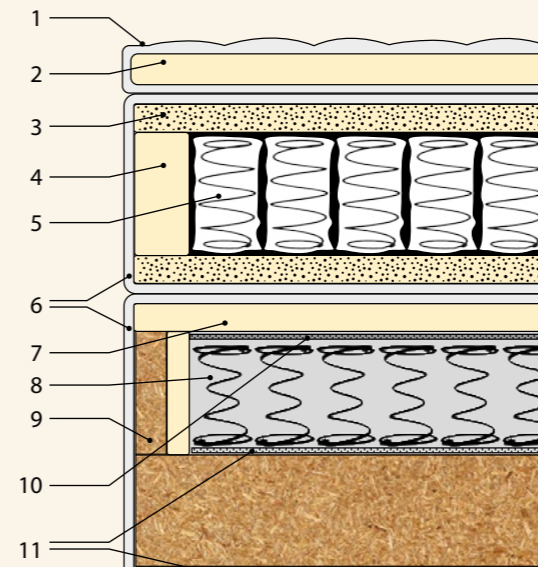

1. Higieninio čiužinio užvalkalas
2. Porolonas T - 25 kg/m³, h - 7 cm
3. Didelio elastingumo porolonas HR - 35 kg/m³, h - 3 cm
4. Porolonas
5. 5 minkštumo zonų kišeninės spyruoklės, h - 13 cm
6. Audinys, laminuotas su 3 mm porolonu
7. Porolonas T - 25 kg/m³, h - 2 cm
8. Bonnell spyruoklės, h - 12 cm
9. MDP dėžė
10. Neaustinė kaišytinė medžiaga
11. Neaustinė medžiaga - sponbondas



1. Top - mattress cover
2. Foam T - 25 kg/m³, h - 7 cm
3. High - resilience foam HR - 35 kg/m³, h - 3 cm
4. Foam
5. 5 firmness zones pocket springs, h - 13 cm
6. Fabric, laminated with 3 mm of foam
7. Foam T - 25 kg/m³, h - 2 cm
8. Bonnell springs, h - 12 cm
9. Chipboard box
10. Non - woven caulked material
11. Non - woven material - sponbond

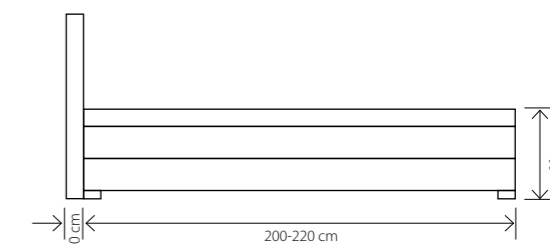
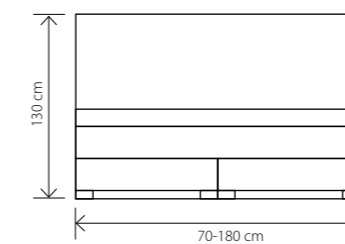

HELSINKI

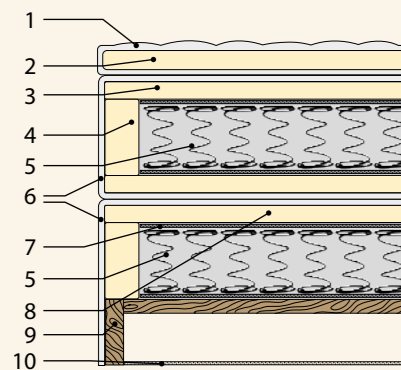

BONNELL / BONNELL



1. Higieninio čiužinio užvalkalas
2. Porolonas T - 25 kg/m³, h - 5 cm
3. Porolonas T - 25 kg/m³, h - 4 cm
4. Porolonas
5. Bonnell spyruoklės, h - 12 cm
6. Audinys, laminuotas su 3 mm porolonu
7. Neaustinė kaišytinė medžiaga
8. Porolonas T - 25 kg/m³, h - 2 cm
9. Medinis rėmas, 12x3 cm
10. Neaustinė medžiaga - sponbondas



1. Top - mattress cover
2. Foam T - 25 kg/m³, h - 5 cm
3. Foam T - 25 kg/m³, h - 4 cm
4. Foam
5. Bonnell springs, h - 12 cm
6. Fabric, laminated with 3 mm of foam
7. Non - woven caulked material
8. Foam T - 25 kg/m³, h - 2 cm
9. Wooden frame, 12x3 cm
10. Non - woven material - sponbond

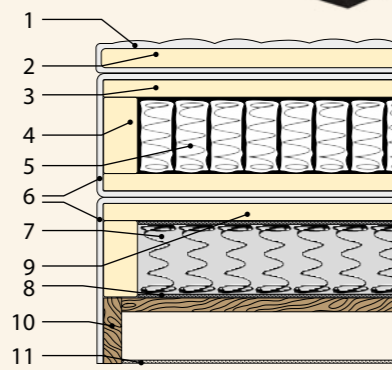

POCKET / BONNELL



1. Higieninio čiužinio užvalkalas
2. Porolonas T - 25 kg/m³, h - 5 cm
3. Porolonas T - 25 kg/m³, h - 4 cm
4. Porolonas
5. 5 minkštumo zonų kišeninės spyruoklės, h - 13 cm
6. Audinys, laminuotas su 3 mm porolonu
7. Bonnell spyruoklės, h - 12 cm
8. Neaustinė kaišytinė medžiaga
9. Porolonas T - 25 kg/m³, h - 2 cm
10. Medinis rėmas, 12x3 cm
11. Neaustinė medžiaga - sponbondas



1. Top - mattress cover
2. Foam T - 25 kg/m³, h - 5 cm
3. Foam T - 25 kg/m³, h - 4 cm
4. Foam
5. 5 firmness zones pocket springs, h - 13 cm
6. Fabric, laminated with 3 mm of foam
7. Bonnell springs, h - 12 cm
8. Non - woven caulked material
9. Foam T - 25 kg/m³, h - 2 cm
10. Wooden frame, 12x3 cm
11. Non - woven material - sponbond

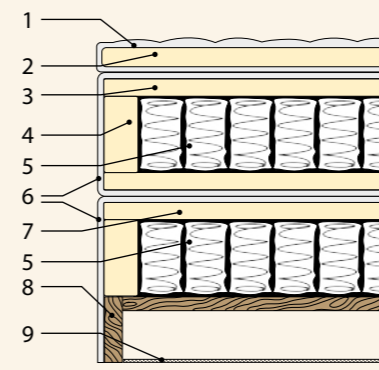

POCKET / POCKET



1. Higieninio čiužinio užvalkalas
2. Porolonas T - 25 kg/m³, h - 5 cm
3. Porolonas T - 25 kg/m³, h - 4 cm
4. Porolonas
5. 5 minkštumo zonų kišeninės spyruoklės, h - 13 cm
6. Audinys, laminuotas su 3 mm porolonu
7. Porolonas T - 25 kg/m³, h - 2 cm
8. Medinis rėmas, 12x3 cm
9. Neaustinė medžiaga - sponbondas



1. Top - mattress cover
2. Foam T - 25 kg/m³, h - 5 cm
3. Foam T - 25 kg/m³, h - 4 cm
4. Foam
5. 5 firmness zones pocket springs, h - 13 cm
6. Fabric, laminated with 3 mm of foam
7. Foam T - 25 kg/m³, h - 2 cm
8. Wooden frame, 12x3 cm
9. Non - woven material - sponbond

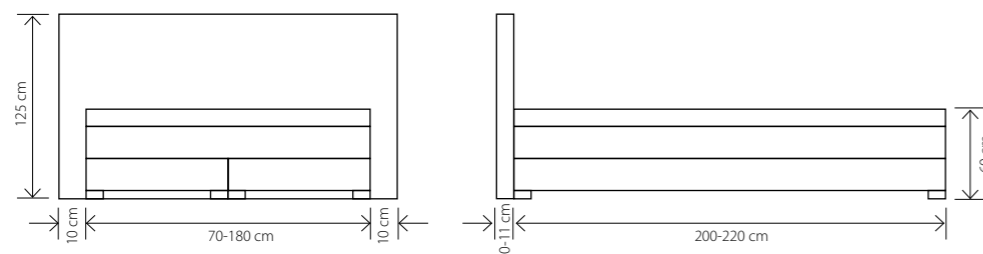

OSAKA

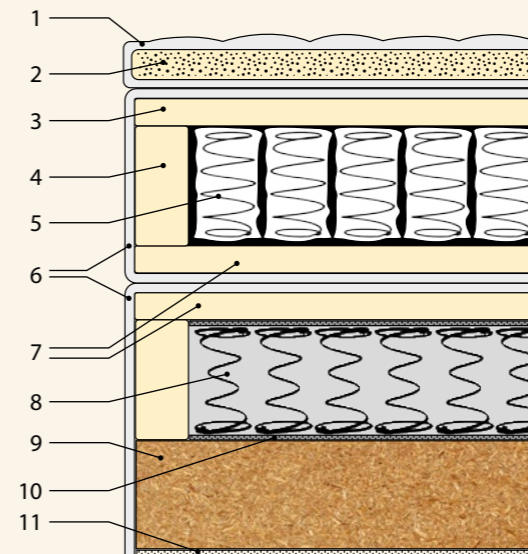

1. Higieninio čiužinio užvalkalas
2. Didelio elastingumo porolonas HR - 35 kg/m³, h - 3 cm
3. Porolonas T - 30 kg/m³, h - 3 cm
4. Porolonas
5. 7 minkštumo zonų kišeninės spyruoklės, h - 13 cm
6. Audinys, laminuotas su 3 mm porolonu
7. Porolonas T - 25 kg/m³, h - 2 cm
8. Bonnell spyruoklės, h - 12 cm
9. MDP dėžė
10. Neaustinė kaišytinė medžiaga
11. Neaustinė medžiaga - sponbondas



1. Top - mattress cover
2. High - resilience foam HR - 35 kg/m³, h - 3 cm
3. Foam T - 30 kg/m³, h - 3 cm
4. Foam
5. 7 firmness zones pocket springs, h - 13 cm
6. Fabric, laminated with 3 mm of foam
7. Foam T - 25 kg/m³, h - 2 cm
8. Bonnell springs, h - 12 cm
9. Chipboard box
10. Non - woven caulked material
11. Non - woven material - sponbond

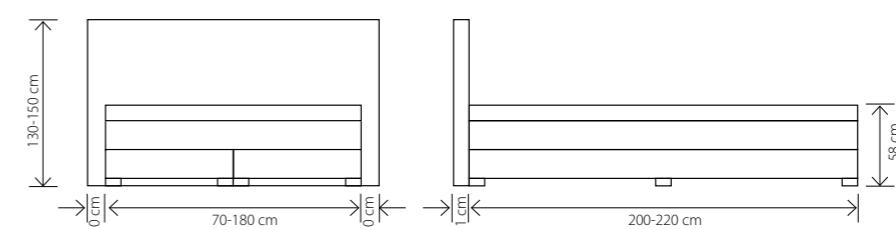

VERONA

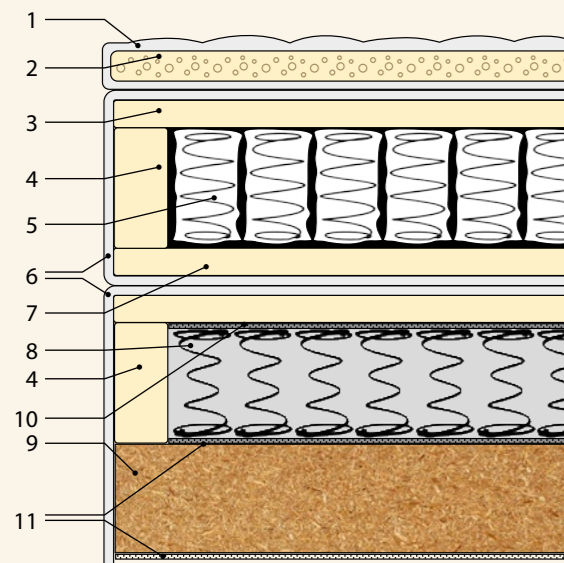

1. Higieninio čiužinio užvalkalas
2. Viskoelastinis porolonas VE - 50 kg/m³, h - 4 cm
3. Porolonas T - 30 kg/m³, h - 3 cm
4. Porolonas
5. 5 minkštumo zonų kišeninės spyruoklės, h - 13 cm
6. Audinys
7. Porolonas T - 25 kg/m³, h - 2 cm
8. Bonnell spyruoklės, h - 11 cm
9. MDP dėžė
10. Neaustinė kaitštinė medžiaga
11. Neaustinė medžiaga - sponbondas



1. Top - mattress cover
2. Visco foam VE - 50 kg/m³, h - 4 cm
3. Foam T - 30 kg/m³, h - 3 cm
4. Foam
5. 5 firmness zones pocket springs, h - 13 cm
6. Fabric
7. Foam T - 25 kg/m³, h - 2 cm
8. Bonnell springs, h - 11 cm
9. Chipboard box
10. Non - woven caulked material
11. Non - woven material - sponbond

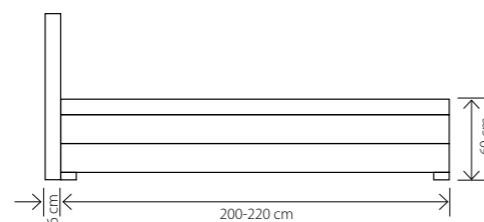
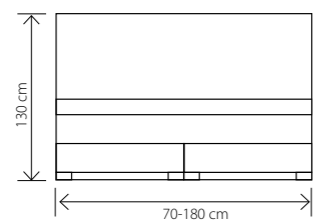

EMKO

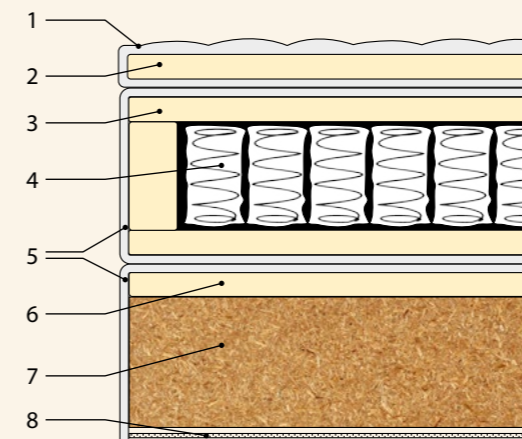

POCKET



1. Higieninio čiužinio užvalkalas
2. Porolonas T - 25 kg/m³, h - 4 cm
3. Porolonas T - 18 kg/m³, h - 2 cm
4. 5 minkštumo zonų kišeninės spyruoklės, h - 13 cm
5. Audinys, laminuotas su 3 mm porolonu
6. Porolonas T - 18 kg/m³, h - 1 cm
7. MDP dėžė
8. Neaustinė medžiaga - sponbondas



1. Top - mattress cover
2. Foam T - 25 kg/m³, h - 4 cm
3. Foam T - 18 kg/m³, h - 2 cm
4. 5 firmness zones pocket springs, h - 13 cm
5. Fabric, laminated with 3 mm of foam
6. Foam T - 18 kg/m³, h - 1 cm
7. Chipboard box
8. Non - woven material - sponbond

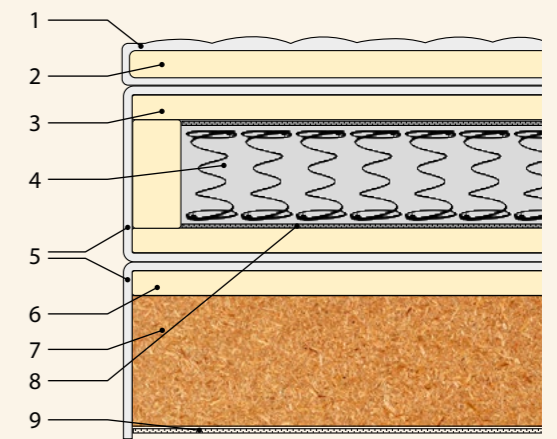

BONNELL



1. Higieninio čiužinio užvalkalas
2. Porolonas T - 25 kg/m³, h - 4 cm
3. Porolonas T - 18 kg/m³, h - 2 cm
4. Bonnell spyruoklės, h - 12 cm
5. Audinys, laminuotas su 3 mm porolonu
6. Porolonas T - 18 kg/m³, h - 1 cm
7. MDP dėžė
8. Neaustinė kaitštinė medžiaga
9. Neaustinė medžiaga - sponbondas



1. Top - mattress cover
2. Foam T - 25 kg/m³, h - 4 cm
3. Foam T - 18 kg/m³, h - 2 cm
4. Bonnell springs, h - 12 cm
5. Fabric, laminated with 3 mm of foam
6. Foam T - 18 kg/m³, h - 1 cm
7. Chipboard box
8. Non - woven caulked material
9. Non - woven material - sponbond

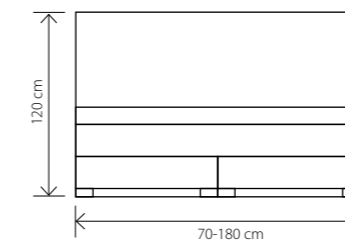

DENVER

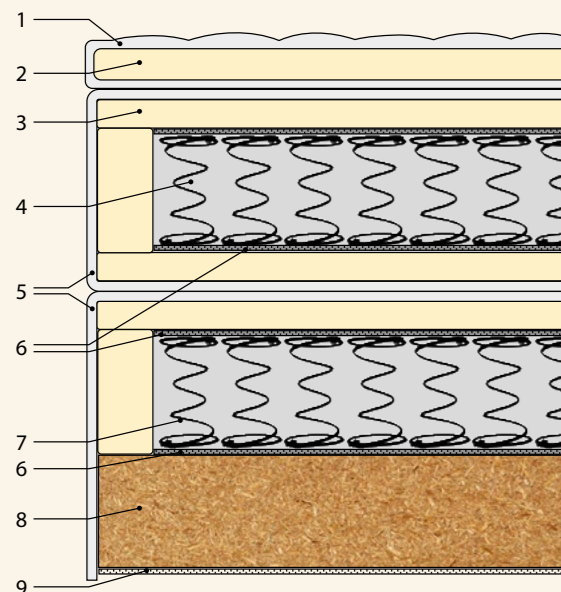

1. Higieninio čiužinio užvalkalas
2. Porolonas T - 18 kg/m³, h - 3 cm
3. Porolonas T - 25 kg/m³, h - 2 cm
4. Bonnell spyruoklės, h - 11 cm
5. Audinys, laminuotas su 3 mm porolonu
6. Neaustinė kaišytinė medžiaga
7. Bonnell spyruoklės, h - 11 cm
8. MPD dėžė
9. Neaustinė medžiaga - sponbondas



1. Top - mattress cover
2. Foam T - 18 kg/m³, h - 3 cm
3. Foam T - 25 kg/m³, h - 2 cm
4. Bonnell springs, h - 11 cm
5. Fabric, laminated with 3 mm of foam
6. Non - woven caulked material
7. Bonnell springs, h - 11 cm
8. Chipboard box
9. Non - woven material - sponbond

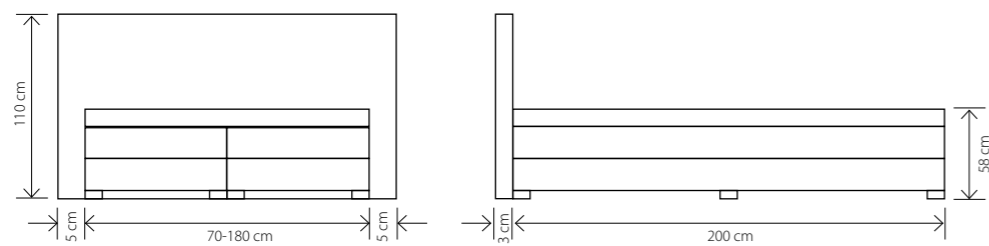

CAPI

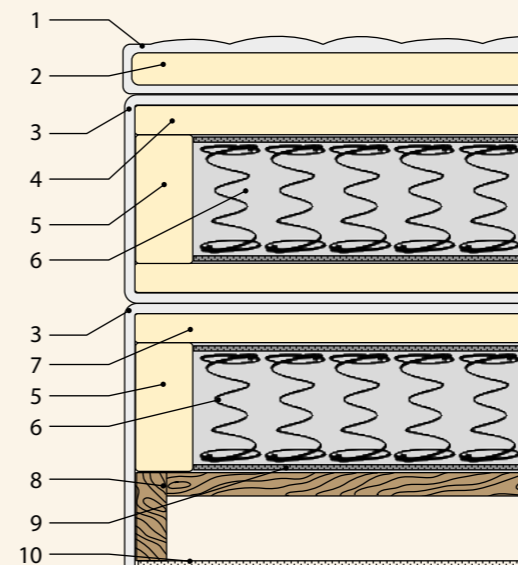

1. Higieninio čiužinio užvalkalas
2. Porolonas T - 25 kg/m³, h - 3 cm
3. Audinys, laminuotas su 3 mm porolonu
4. Porolonas T - 25 kg/m³, h - 4 cm
5. Porolonas
6. Bonnell spyruoklės, h - 12 cm
7. Porolonas T - 25 kg/m³, h - 2 cm
8. Medinis rėmas, 8x4 cm
9. Neaustinė kaišytinė medžiaga
10. Neaustinė medžiaga - sponbondas



1. Top - mattress cover
2. Foam T - 25 kg/m³, h - 3 cm
3. Fabric, laminated with 3 mm of foam
4. Foam T - 25 kg/m³, h - 4 cm
5. Foam
6. Bonnell springs, h - 12 cm
7. Foam T - 25 kg/m³, h - 2 cm
8. Wooden frame, 8x4 cm
9. Non - woven caulked material
10. Non - woven material - sponbond

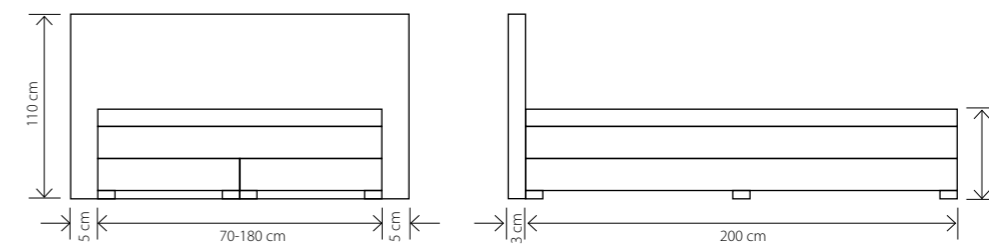

CLOUD

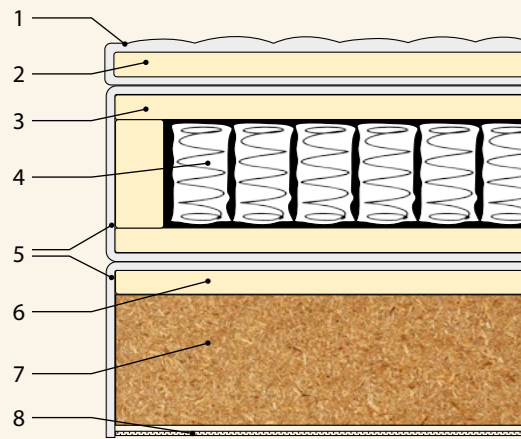

POCKET



1. Higieninio čiuzinio užvalkalas
2. Porolonas T - 25 kg/m³, h - 4 cm
3. Porolonas T - 18 kg/m³, h - 2 cm
4. 5 minkštumo zonų kišeninės spyruoklės, h - 13 cm
5. Audinys, laminuotas su 3 mm porolonu
6. Porolonas T - 18 kg/m³, h - 1 cm
7. MDP dėžė
8. Neaustinė medžiaga - sponbondas



1. Top - mattress cover
2. Foam T - 25 kg/m³, h - 4 cm
3. Foam T - 18 kg/m³, h - 2 cm
4. 5 firmness zones pocket springs, h - 13 cm
5. Fabric, laminated with 3 mm of foam
6. Foam T - 18 kg/m³, h - 1 cm
7. Chipboard box
8. Non - woven material - sponbond

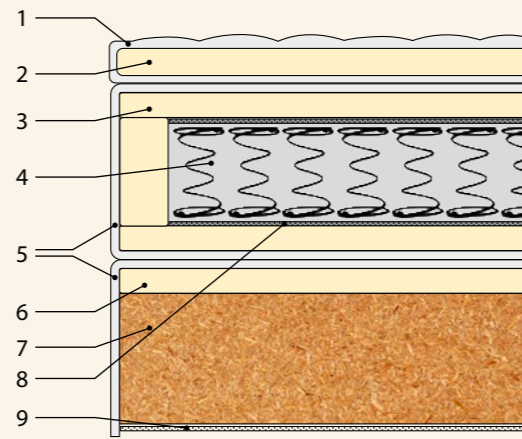

BONNELL



1. Higieninio čiuzinio užvalkalas
2. Porolonas T - 25 kg/m³, h - 4 cm
3. Porolonas T - 18 kg/m³, h - 2 cm
4. Bonnell spyruoklės, h - 12 cm
5. Audinys, laminuotas su 3 mm porolonu
6. Porolonas T - 18 kg/m³, h - 1 cm
7. MDP dėžė
8. Neaustinė kaišytinė medžiaga
9. Neaustinė medžiaga - sponbondas



1. Top - mattress cover
2. Foam T - 25 kg/m³, h - 4 cm
3. Foam T - 18 kg/m³, h - 2 cm
4. Bonnell springs, h - 12 cm
5. Fabric, laminated with 3 mm of foam
6. Foam T - 18 kg/m³, h - 1 cm
7. Chipboard box
8. Non - woven caulked material
9. Non - woven material - sponbond

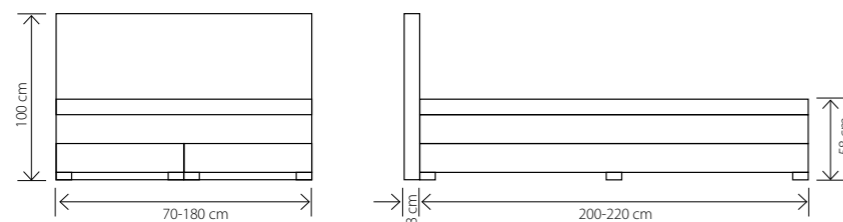

SUZZY

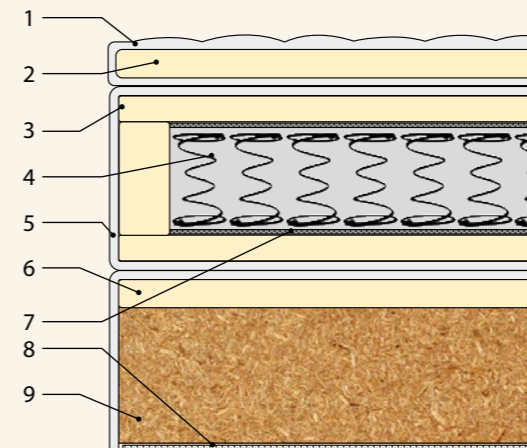

1. Higieninio čiuzinio užvalkalas
2. Porolonas T - 18 kg/m³, h - 3 cm
3. Porolonas T - 18 kg/m³, h - 2 cm
4. Bonnell spyruoklės, h - 12 cm
5. Audinys
6. Porolonas T-18 kg/m³, h - 1 cm
7. Neaustinė kaišytinė medžiaga
8. Neaustinė medžiaga - sponbondas
9. MDP dėžė



1. Top - mattress cover
2. Foam T - 18 kg/m³, h - 3 cm
3. Foam T - 18 kg/m³, h - 2 cm
4. Bonnell springs, h - 12 cm
5. Fabric
6. Foam T-18 kg/m³, h - 1 cm
7. Non - woven caulked material
8. Non - woven material - sponbond
9. Chipboard box

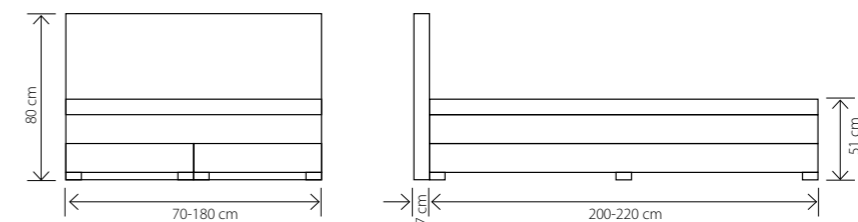

DOUBLE BED

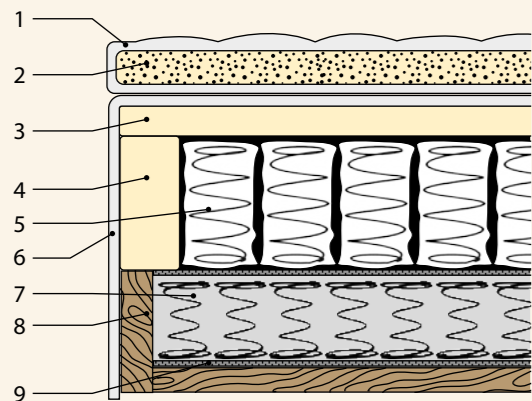

1. Higieninio čiužinio užvalkalas
2. Didelio elastingumo porolonas HR - 35 kg/m³, h - 4cm
3. Porolonas T - 25 kg/m³, h - 2 cm
4. Porolonas
5. 5 minkštumo zonų kišeninės spyruoklės, h - 13 cm
6. Audinys, laminuotas su 3 mm porolonu
7. Bonnell spyruoklės, h - 11 cm
8. Medinis rėmas, 12x3 cm
9. Neaustinė kaišytinė medžiaga



1. Top - mattress cover
2. High - resilience foam HR - 35 kg/m³, h - 4 cm
3. Foam T - 25 kg/m³, h - 2 cm
4. Foam
5. 5 firmness zones pocket springs, h - 13 cm
6. Fabric, laminated with 3 mm of foam
7. Bonnell springs, h - 11 cm
8. Wooden frame, 12x3 cm
9. Non - woven caulked material

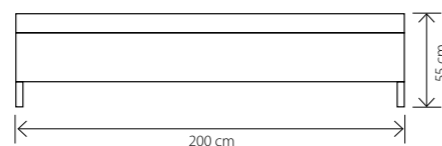
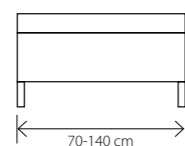

HARMONY



HARMONY**

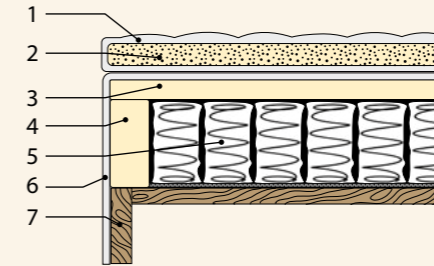

1. Higieninio čiužinio užvalkalas
2. Porolonas T - 25 kg/m³, h - 3 cm
3. Porolonas T - 25 kg/m³, h - 2 cm
4. Porolonas
5. 5 minkštumo zonų kišeninės spyruoklės, h - 13 cm
6. Audinys
7. Medinis rėmas, 8x4 cm



1. Top-mattress cover
2. Foam T - 25 kg/m³, h - 3 cm
3. Foam T - 25 kg/m³, h - 2 cm
4. Foam
5. 5 firmness zones pocket springs, h - 13 cm
6. Fabric
7. Wooden frame, 8x4 cm

HARMONY****

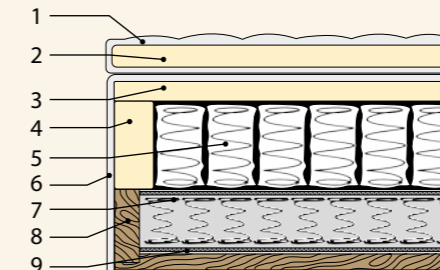

1. Higieninio čiužinio užvalkalas
2. Porolonas T - 25 kg/m³, h - 3 cm
3. Porolonas T - 25 kg/m³, h - 2 cm
4. Porolonas
5. 5 minkštumo zonų kišeninės spyruoklės, h - 13 cm
6. Audinys
7. Mini bonnell spyruoklės, h - 7 cm
8. Medinis rėmas, 8x4 cm
9. Neaustinė kaišytinė medžiaga



1. Top-mattress cover
2. Foam T - 25 kg/m³, h - 3 cm
3. Foam T - 25 kg/m³, h - 2 cm
4. Foam
5. 5 firmness zones pocket springs, h - 13 cm
6. Fabric
7. Mini bonnell springs, h - 7 cm
8. Wooden frame, 8x4 cm
9. Non - woven caulked material

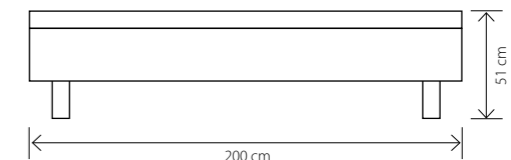
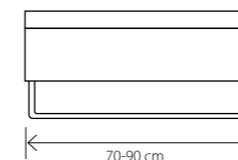

HARMONY*

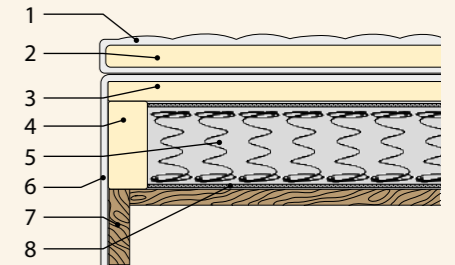

1. Higieninio čiužinio užvalkalas
2. Porolonas T - 25 kg/m³, h - 3 cm
3. Porolonas T - 25 kg/m³, h - 2 cm
4. Porolonas
5. Bonnell spyruoklės, h - 12 cm
6. Audinys
7. Medinis rėmas, 8x4 cm
8. Neaustinė kaišytinė medžiaga



1. Top - mattress cover
2. Foam T - 25 kg/m³, h - 3 cm
3. Foam T - 25 kg/m³, h - 2 cm
4. Foam
5. Bonnell springs, h - 12 cm
6. Fabric
7. Wooden frame, 8x4 cm
8. Non - woven caulked material

HARMONY***

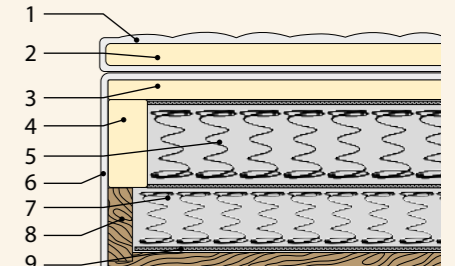

1. Higieninio čiužinio užvalkalas
2. Porolonas T - 25 kg/m³, h - 3 cm
3. Porolonas T - 25 kg/m³, h - 2 cm
4. Porolonas
5. Bonnell spyruoklės, h - 12 cm
6. Audinys
7. Mini bonnell spyruoklės, h - 7 cm
8. Medinis rėmas, 8x4 cm
9. Neaustinė kaišytinė medžiaga



1. Top - mattress cover
2. Foam T - 25 kg/m³, h - 3 cm
3. Foam T - 25 kg/m³, h - 2 cm
4. Foam
5. Bonnell springs, h - 12 cm
6. Fabric
7. Mini bonnell springs, h - 7 cm
8. Wooden frame, 8x4 cm
9. Non - woven caulked material

HARMONY*****

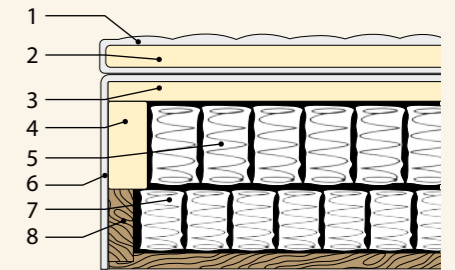

1. Higieninio čiužinio užvalkalas
2. Porolonas T - 25 kg/m³, h - 3 cm
3. Porolonas T - 25 kg/m³, h - 2 cm
4. Porolonas
5. 5 minkštumo zonų kišeninės spyruoklės, h - 13 cm
6. Audinys
7. Mini kišeninės spyruoklės, h - 5 cm
8. Medinis rėmas, 8x4 cm



1. Top - mattress cover
2. Foam T - 25 kg/m³, h - 3 cm
3. Foam T - 25 kg/m³, h - 2 cm
4. Foam
5. 5 firmness zones pocket springs, h - 13 cm
6. Fabric
7. Mini pocket springs, h - 5 cm
8. Wooden frame, 8x4 cm

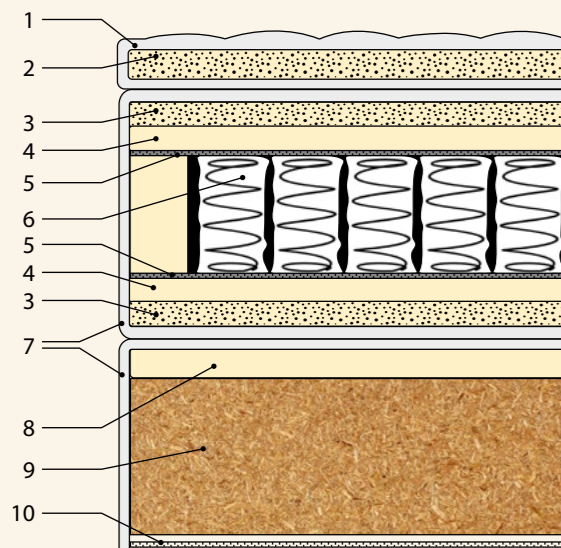

1. Higieninis čiužinio užvalkalas
2. Didelio elastingumo porolonas HR - 35 kg/m³, h - 4 cm
3. Didelio elastingumo porolonas HR - 35 kg/m³, h - 3 cm
4. Porolonas RG - 60 kg/m³, h - 3 cm
5. Neaustinė kaišytinė medžiaga
6. 7 minkštumo zonų „multipocket“ kišeninės spyruoklės su metaliniu rėmeliu, h - 15 cm
7. Audinys
8. Porolonas T - 25 kg/m³, h - 0,3 cm
9. MDP dėžė
10. Neaustinė medžiaga-sponbondas



1. Top - mattress cover
2. Hight - resilience foam HR - 35 kg/m³, h - 4 cm
3. Hight - resilience foam HR - 35 kg/m³, h - 3 cm
4. Foam RG - 60 kg/m³, h - 3 cm
5. Non - woven caulked material
6. 7 firmness zones multi pocket springs with metal frame, h - 15 cm
7. Fabric
8. Foam T - 25 kg/m³, h - 0,3 cm
9. Chipboard box
10. Non - woven material - sponbond

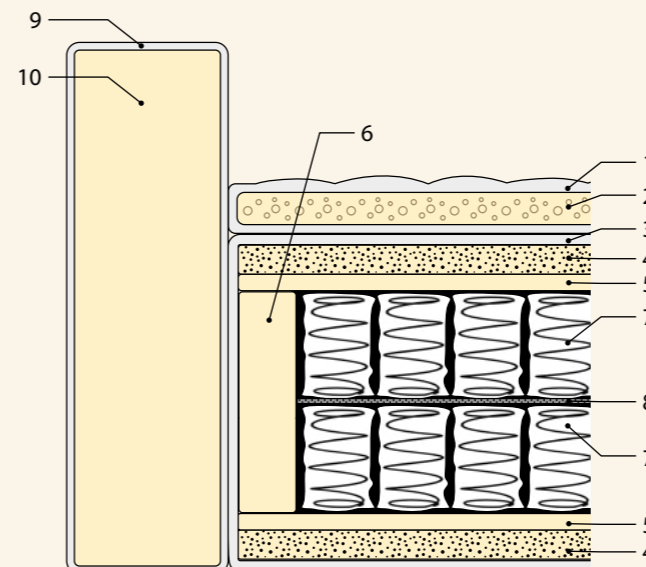
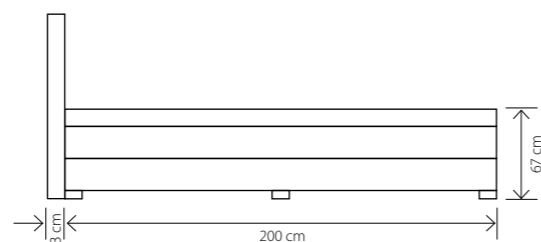
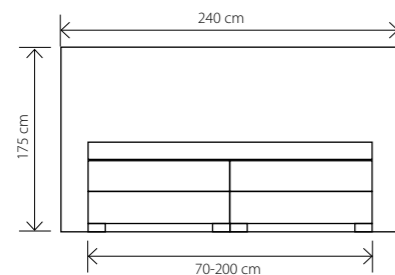

1. Higieninis čiužinio užvalkalas
2. Viskoelastinis porolonas VE - 57 kg/m³, h - 3 cm
3. Čiužinio užvalkalas, daigstytas su 100g PES
4. Didelio elastingumo porolonas HR - 35 kg/m³, h - 2 cm
5. Porolonas RG - 60 kg/m³, h - 1 cm
6. Porolonas RG - 60 kg/m³, d - 5 cm
7. 5 minkštumo zonų kišeninės spyruoklės, h - 13 cm
8. Neaustinė kaišytinė medžiaga
9. Audinys
10. Porolonas RG - 60 kg/m³, d - 15 cm



1. Top - mattress cover
2. Visco foam HR - 57 kg/m³, h - 3 cm
3. Mattress cover quilted with 100g PES
4. Hight - resilience foam HR - 35 kg/m³, h - 2 cm
5. Foam RG - 60 kg/m³, h - 1 cm
6. Foam RG - 60 kg/m³, d - 5 cm
7. 5 firmness zones pocket springs, h - 13 cm
8. Non - woven caulked material
9. Fabric
10. Foam RG - 60 kg/m³, d - 15 cm

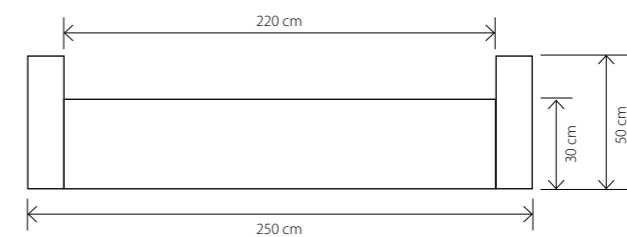

MONACO

FUNCTION UP / DOWN



DOWN



UP

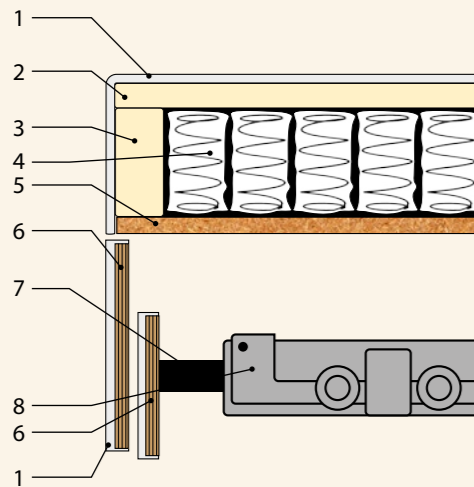

1. Audinys, laminuotas su 3 mm porolonu
2. Porolonas T - 25 kg/m³, h - 2 cm
3. Porolonas
4. 5 minkštumo zonų kišeninės spyruoklės, h - 13 cm
5. MDP
6. Fanera
7. Metalinis rėmas
8. Motoras



1. Fabric, laminated with 3 mm of foam
2. Foam T - 25 kg/m³, h - 2 cm
3. Foam
4. 5 firmness zones pocket springs, h - 13 cm
5. Chipboard
6. Plywood
7. Metal frame
8. Motor

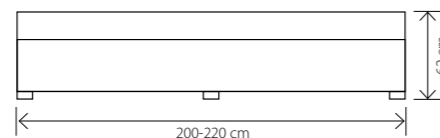
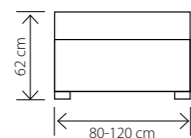

KAMASUTRA

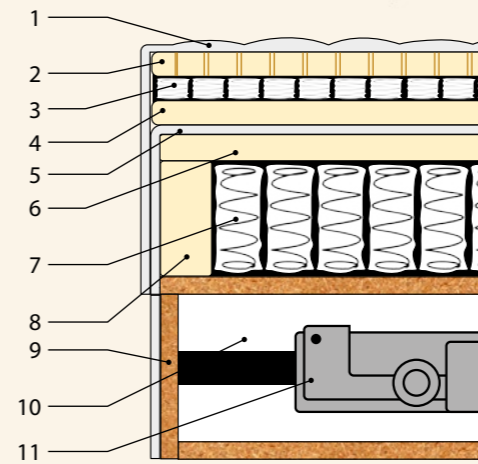

1. Audinys, laminuotas su 3 mm porolonu
2. Lateksas, h - 3 cm
3. Mikro kišeninės spyruoklės, h - 3 cm
4. Porolonas T - 25 kg/m³, h - 3 cm
5. Vidinis užvalkalas
6. Porolonas T - 25 kg/m³, h - 2 cm
7. 7 minkštumo zonų „multi pocket“ kišeninės spyruoklės, h - 15 cm
8. Porolonas
9. MDP
10. Metalinis rėmas su motoru
11. LMDP dėžė patalynei

* Galimybė lovą valdyti su mobiliąja programėle telefone



1. Fabric, laminated with 3 mm of foam
2. Latex, h - 3 cm
3. Micro pocket springs, h - 3 cm
4. Foam T - 25 kg/m³, h - 3 cm
5. Inner cover
6. Foam T - 25 kg/m³, h - 2 cm
7. 7 firmness zones multi pocket springs, h - 15 cm
8. Foam
9. Chipboard
10. Metal frame with motor
11. Laminated chipboard linen case

* Option to control bed with an app from your mobile phone

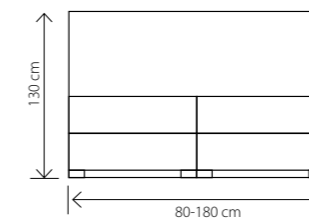

NIRVANA

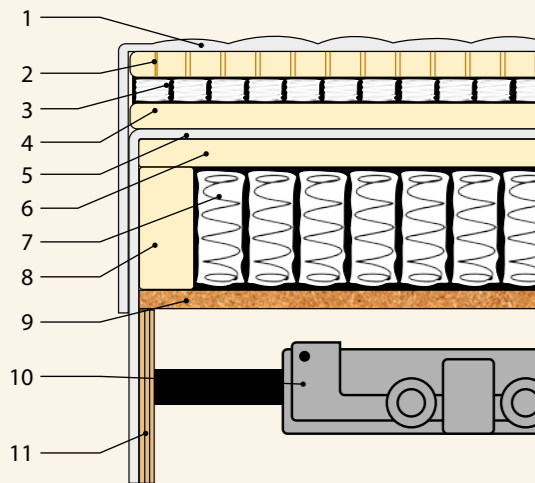

1. Audinys, laminuotas su 3 mm porolonu
2. Lateksas, h - 3 cm
3. Mikro kišeninės spyruoklės, h - 3 cm
4. Porolonas T - 25 kg/m³, h - 3 cm
5. Vidinis užvalkalas
6. Porolonas T - 25 kg/m³, h - 2 cm
7. 7 minkštumo zonų „multi pocket“ kišeninės spyruoklės, h - 15 cm
8. Porolonas
9. MDP
10. Metalinis rėmas su motoru
11. Fanera



1. Fabric, laminated with 3 mm of foam
2. Latex, h - 3 cm
3. Micro pocket springs, h - 3 cm
4. Foam T - 25 kg/m³, h - 3 cm
5. Inner cover
6. Foam T - 25 kg/m³, h - 2 cm
7. 7 firmness zones multi pocket springs, h - 15 cm
8. Foam
9. Chipboard
10. Metal frame with motor
11. Plywood

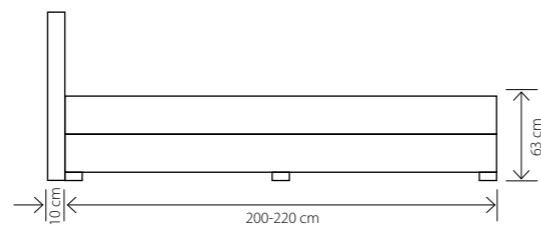
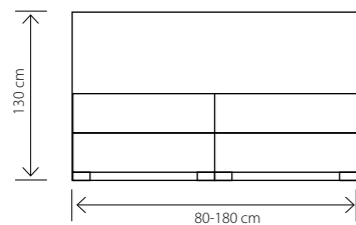

OSLO

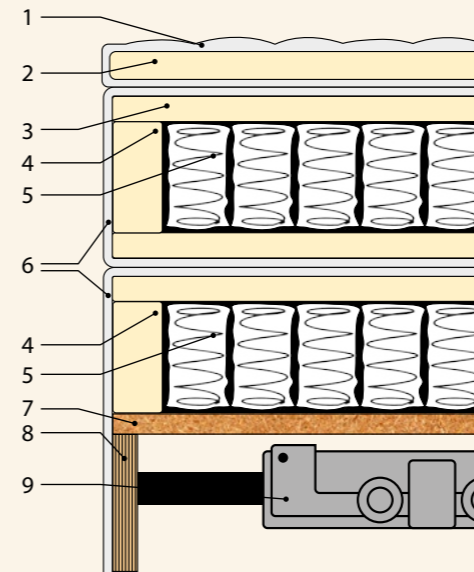

1. Higieninio čiužinio užvalkalas
2. Porolonas T - 25 kg/m³, h - 5 cm
3. Porolonas T - 25 kg/m³, h - 2 cm
4. Porolonas
5. 5 minkštumo zonų kišeninės spyruoklės, h - 13 cm
6. Audinys, laminuotas su 3 mm porolonu
7. MDP
8. Fanera
9. Metalinis rėmas su motoru



1. Top-mattress cover
2. Foam T - 25 kg/m³, h - 5 cm
3. Foam T - 25 kg/m³, h - 2 cm
4. Foam
5. 5 firmness zones pocket springs, h - 13 cm
6. Fabric, laminated with 3 mm of foam
7. Chipboard
8. Plywood
9. Metal frame with motor

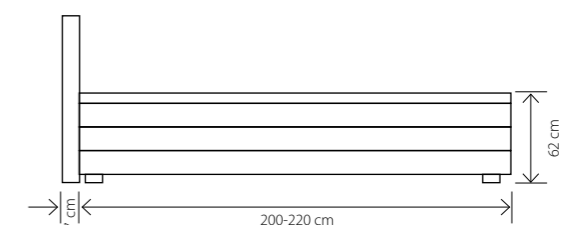
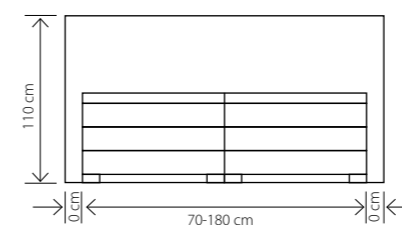

MODENA

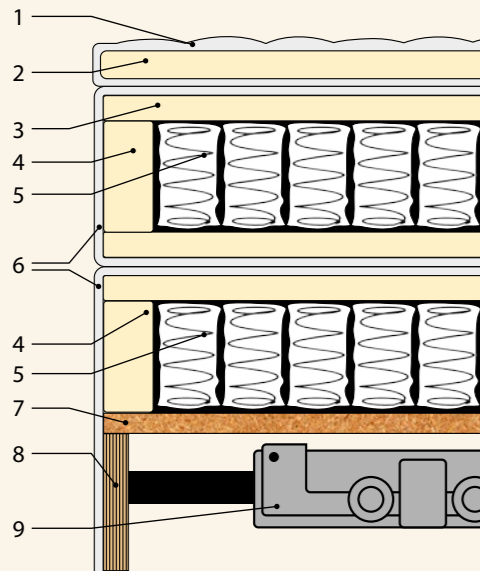

1. Higieninio čiužinio užvalkalas
2. Porolonas T - 25 kg/m³, h - 5 cm
3. Porolonas T - 25 kg/m³, h - 2 cm
4. Porolonas
5. 5 minkštumo zonų kišeninės spyruoklės, h - 13 cm
6. Audinys, laminuotas su 3 mm porolonu
7. MDP
8. Fanera
9. Metalinis rėmas su motoru OctoBox



1. Top - mattress cover
2. Foam T - 25 kg/m³, h - 5 cm
3. Foam T - 25 kg/m³, h - 2 cm
4. Foam
5. 5 firmness zones pocket springs, h - 13 cm
6. Fabric, laminated with 3 mm of foam
7. Chipboard
8. Plywood
9. Metal frame with motor OctoBox

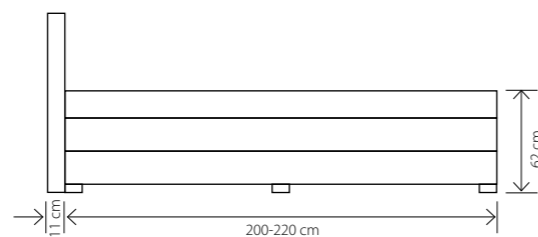

MILANO

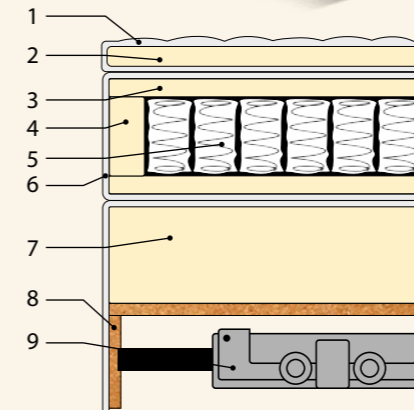

POCKET / FOAM



1. Higieninio čiužinio užvalkalas
2. Porolonas T - 25 kg/m³, h - 4 cm
3. Porolonas T - 25 kg/m³, h - 2 cm
4. Porolonas
5. 5 minkštumo zonų kišeninės spyruoklės, h - 13 cm
6. Audinys, laminuotas su 3 mm porolonu
7. Porolonas T - 18 kg/m³, h - 12 cm
8. MDP
9. Metalinis rėmas su motoru



1. Top - mattress cover
2. Foam T - 25 kg/m³, h - 4 cm
3. Foam T - 25 kg/m³, h - 2 cm
4. Foam
5. 5 firmness zones pocket springs, h - 13 cm
6. Fabric, laminated with 3 mm of foam
7. Foam T - 18 kg/m³, h - 12 cm
8. MDP
9. Metal frame with motor

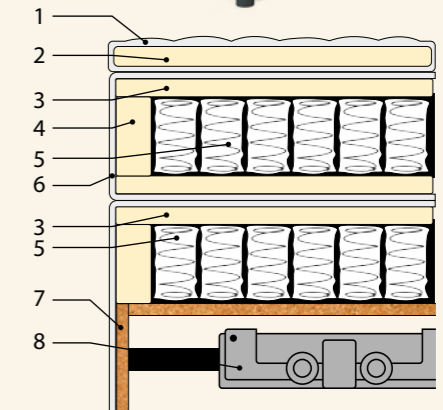

POCKET / POCKET



1. Higieninio čiužinio užvalkalas
2. Porolonas T - 25 kg/m³, h - 4 cm
3. Porolonas T - 25 kg/m³, h - 2 cm
4. Porolonas
5. 5 minkštumo zonų kišeninės spyruoklės, h - 13 cm
6. Audinys, laminuotas su 3 mm porolonu
7. MDP
8. Metalinis rėmas su motoru



1. Top - mattress cover
2. Foam T - 25 kg/m³, h - 4 cm
3. Foam T - 25 kg/m³, h - 2 cm
4. Foam
5. 5 firmness zones pocket springs, h - 13 cm
6. Fabric, laminated with 3 mm of foam
7. Chipboard
8. Metal frame with motor

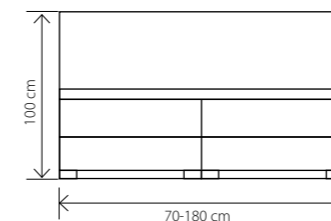

SIMPLE ELECTRO

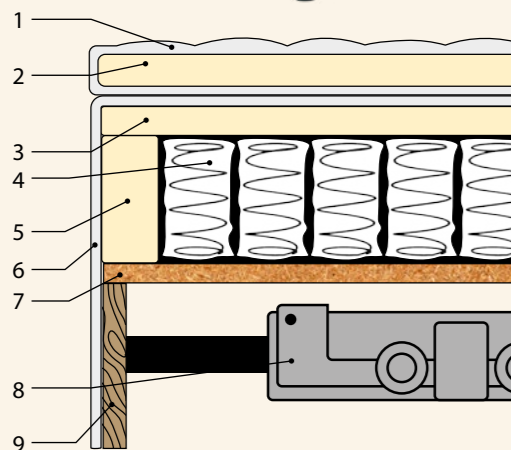

1. Higieninio čiužinio užvalkalas
2. Porolonas T - 18 kg/m³, h - 3 cm
3. Porolonas T - 25 kg/m³, h - 2 cm
4. 5 minkštumo zonų kišeninės spyruoklės, h - 13 cm
5. Porolonas
6. Audinys, laminuotas su 3 mm porolonu
7. MDP
8. Metalinis rėmas su motoru
9. Medinis rėmas 12x3 cm



1. Top - mattress cover
2. Foam T - 18 kg/m³, h - 3 cm
3. Foam T - 25 kg/m³, h - 2 cm
4. 5 firmness zones pocket springs, h - 13 cm
5. Foam
6. Fabric, laminated with 3 mm of foam
7. Chipboard
8. Metal frame with motor
9. Wooden frame 12x3 cm

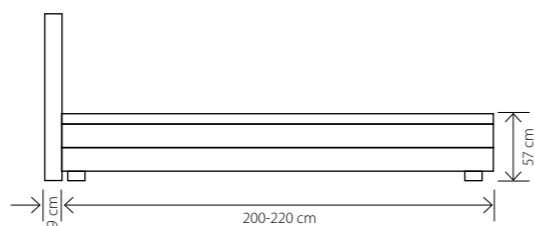
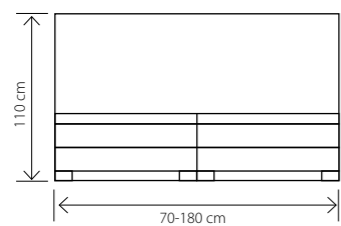

GALVŪGALIAI / HEADBOARDS

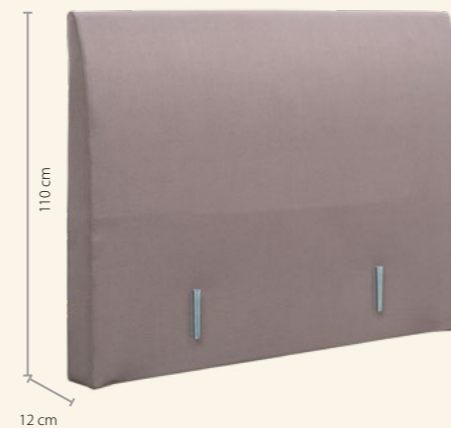

RASMUS PIPING

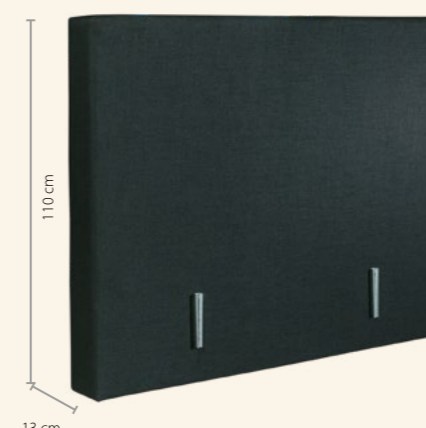

STANDART

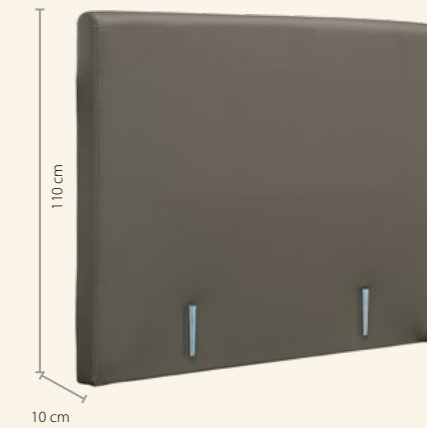

ORLANDO ROUNDED

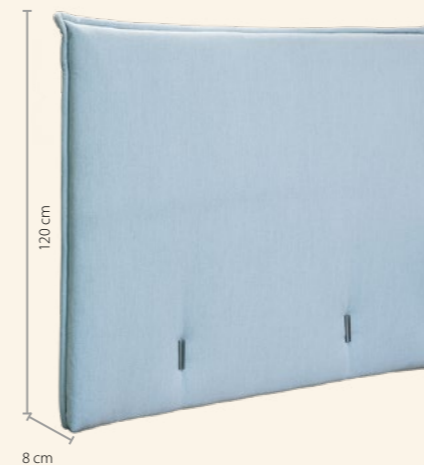

CAMILLE

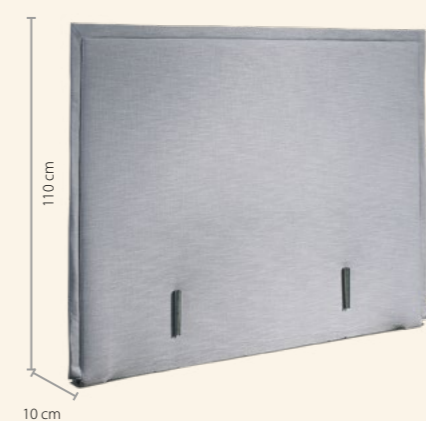

SIMPLE

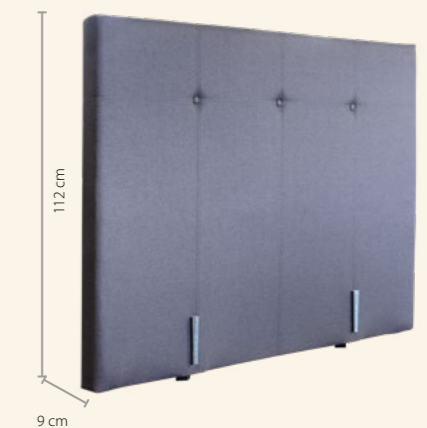

SORRENTO

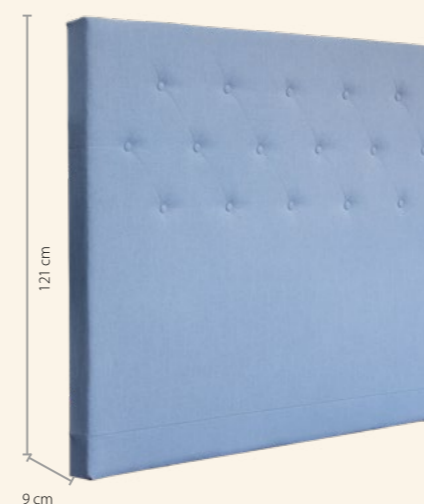

ALLEGRO

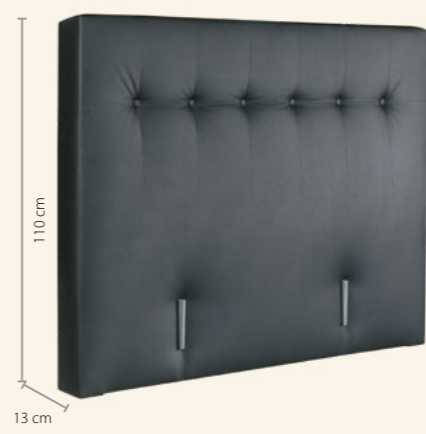

CAPI

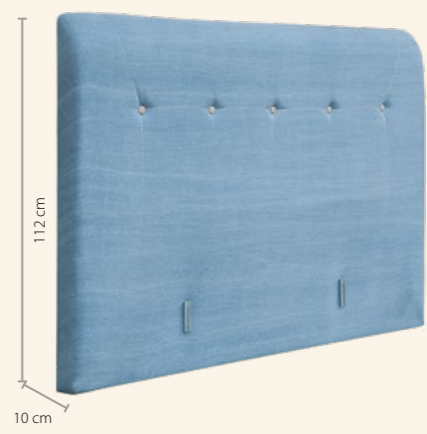

LIVORNO

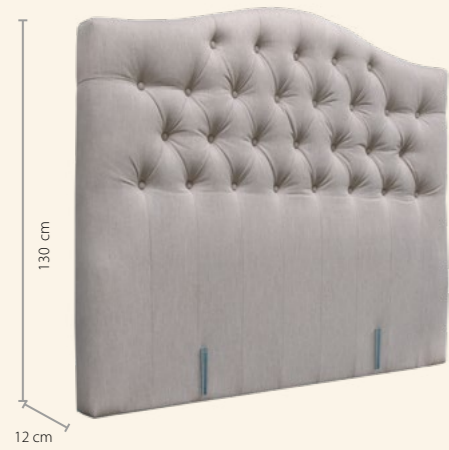

LENAVA

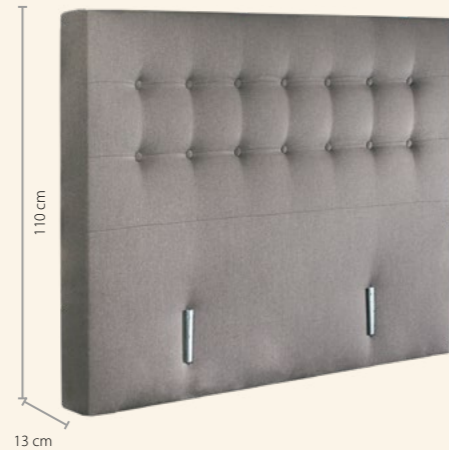

BUTTON

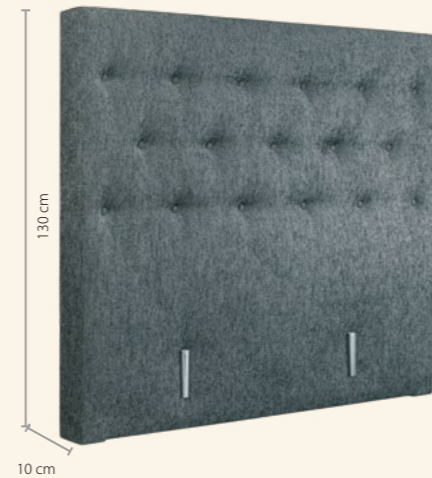

TURKU

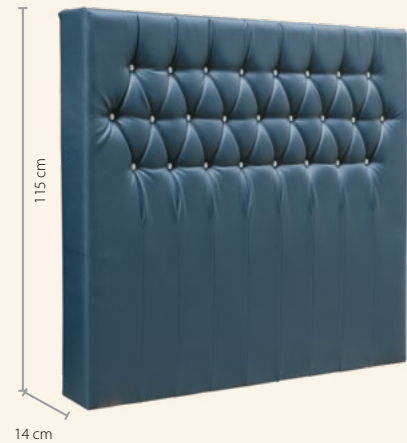

DIVA



SENCE



CASTLE

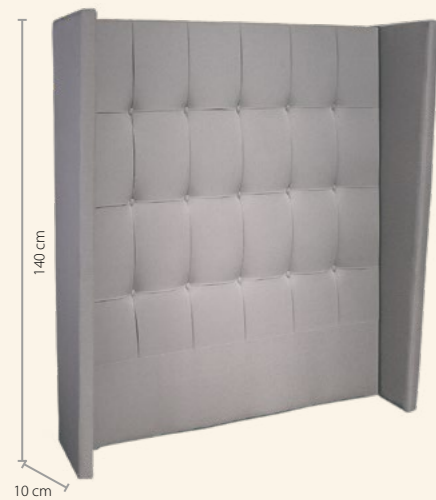

LOG

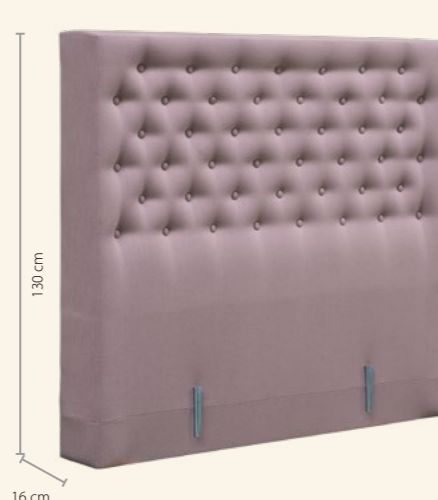

BOSTON

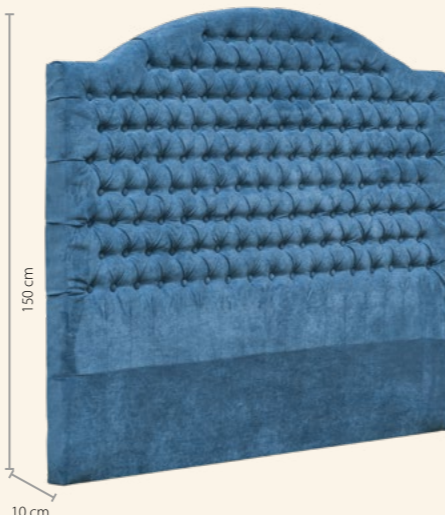

BOSSO



ROMBAS



CAMBRIDGE

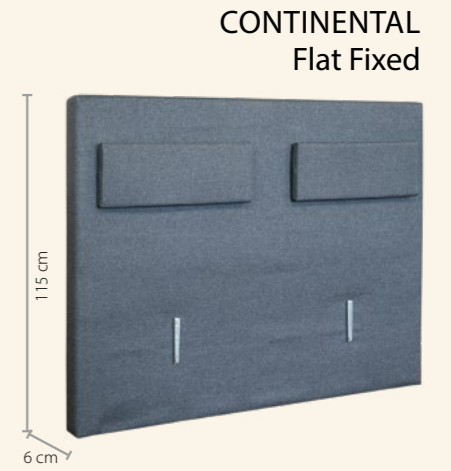

**CONTINENTAL
Flat Fixed**



SQUARE

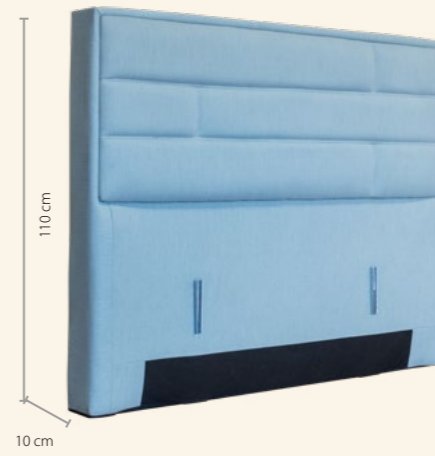

KWATRO

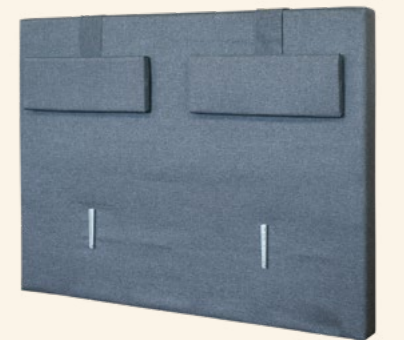

**CONTINENTAL
Flat Hanging**

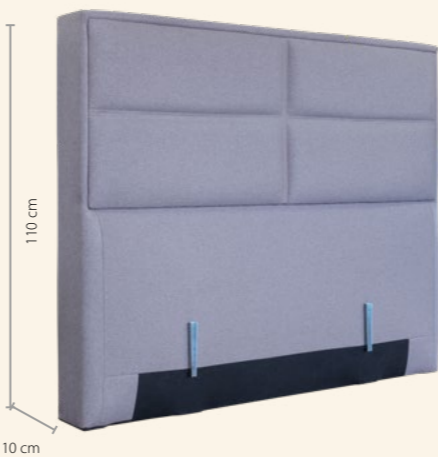

MERCURE



KRISTA

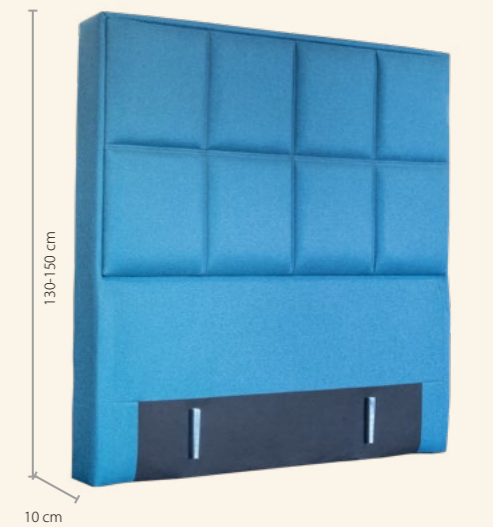

ATLAS

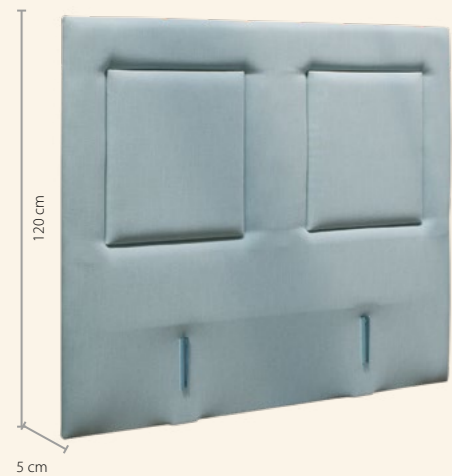

QUADRO

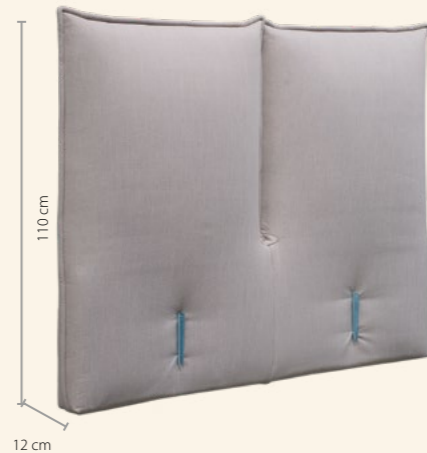

CAMILLE PLUS

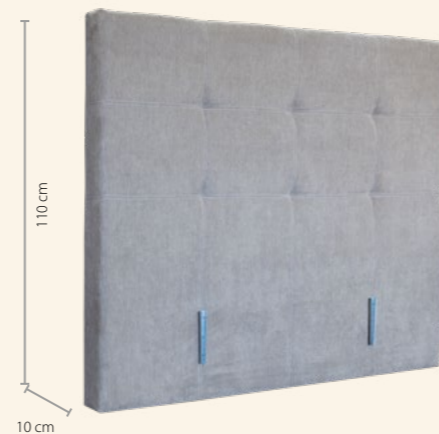

NORDIC

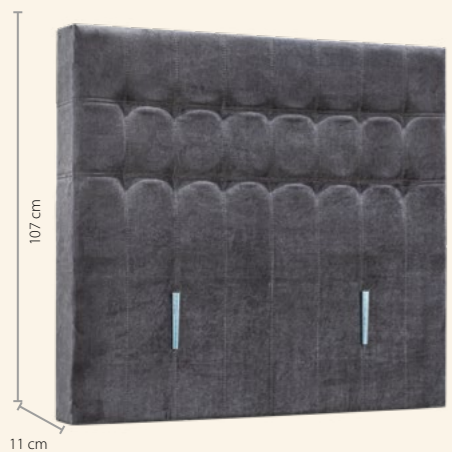

HALMSTAD

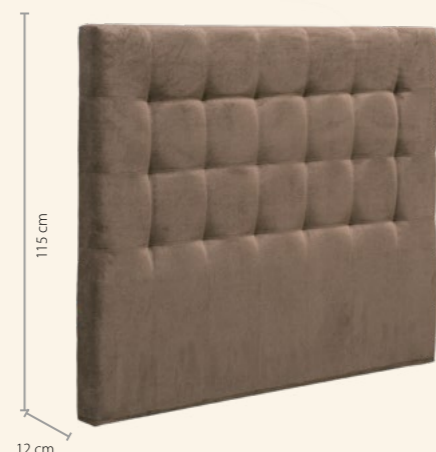

STEGO MAX

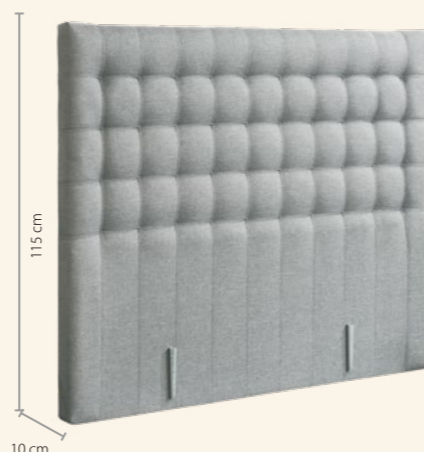

STEGO

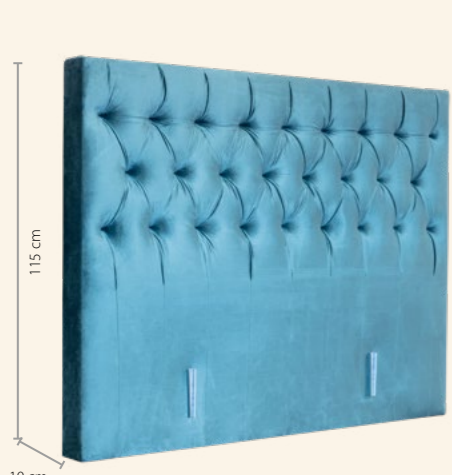

CHESTERFIELD

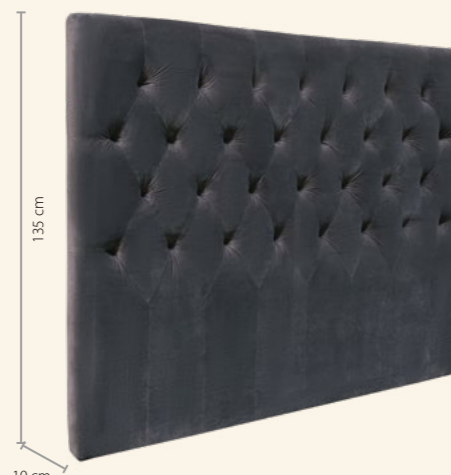

FOUR BUTTON ROWS

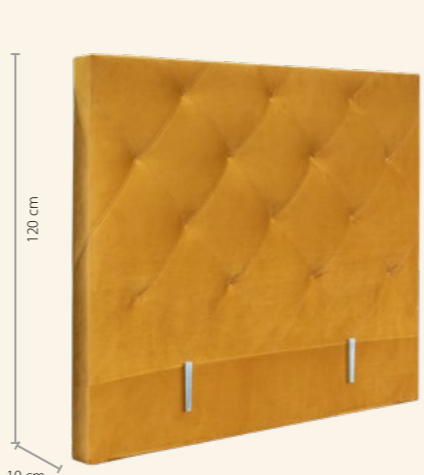

EMKO



PREZIDENTAS



Čiužinys su 7 minkštumo zonų kišeninėmis spyruoklėmis, h – 27 cm

1. Čiužinio užvalkalas, daigstytas 1 cm viskoelastiniu porolonu
2. Lateksas SOFT, h – 2 cm
3. Poliuretano putos RG-60 kg/m³, h – 2 cm
4. Neaustinė kaišytinė medžiaga
5. Poliuretano putos RG-60 kg/m³, d-5 cm
6. 7 minkštumo zonų „multipocket“ kišeninės spyruoklės su metaliniu rėmeliu, h – 15 cm
7. Viskoelastinės poliuretano putos VE-50 kg/m³, h-3 cm



Mattress with 7 firmness zones pocket springs, h – 27 cm

1. Mattress cover quilted with 1 cm visco foam.
2. Latex SOFT, h-3 cm
3. Foam RG-60 kg/m³, h-2cm
4. Non-woven calked material
5. Foam RG-60 kg/m³, d-5 cm
6. 7 firmness zones „multipocket“ springs with metal frame, h-15 cm
7. Visco foam VE-50 kg/m³, h-3 cm

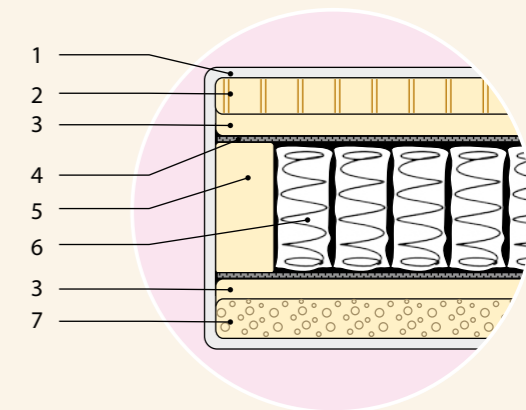



HAVANA



Čiužinys su 7 minkštumo zonų kišeninėmis spyruoklėmis, h – 25 cm

1. Čiužinio užvalkalas, daigstytas su 200 g PES
2. Lateksas, h – 2 cm
3. Kokoso pluoštas 75 kg/m³, h – 2 cm
4. Porolonas
5. 7 minkštumo zonų „multipocket“ kišeninės spyruoklės, h – 15 cm



Mattress with 7 firmness zones pocket springs, h – 25 cm

1. Mattress cover quilted with 200 g PES
2. Latex, h – 2 cm
3. Coconut fiber 75 kg/m³, h – 2 cm
4. Foam
5. 7 firmness zones „multipocket“ springs, h – 15 cm

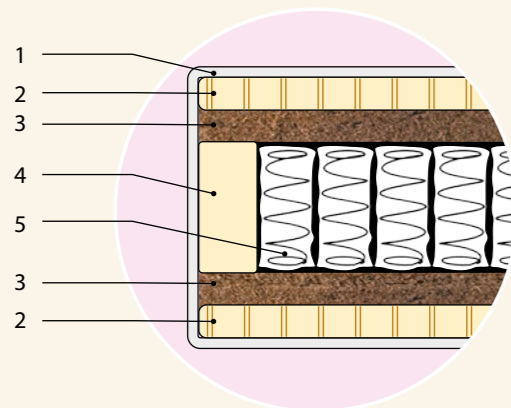

SILVA žiema/vasara



Čiužinys su 7 minkštumo zonų kišeninėmis spyruoklėmis, h – 25 cm

1. Čiužinio užvalkalas, daigstytas su 200 g PES
2. Lateksas su želė gabaliukais GEL INFUSED, h – 4 cm
3. Porolonas
4. 7 minkštumo zonų „multipocket“ kišeninės spyruoklės, h – 15 cm
5. Viskoelastinis lateksas RESHAPE, h – 4cm



Mattress with 7 firmness zones pocket springs, h – 25 cm

1. Mattress cover quilted with 200 g PES
2. GEL INFUSED latex, h – 4 cm
3. Foam
4. 7 firmness zones „multipocket“ springs, h – 15 cm
5. Visco-latex RESHAPE, h – 4cm

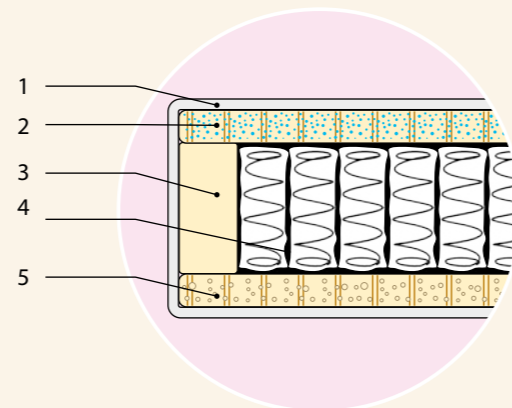

SILVA X-Stream Air



Čiužinys su 7 minkštumo zonų kišeninėmis spyruoklėmis, h – 25 cm

1. Čiužinio užvalkalas, daigstytas su 200 g PES
2. Lateksas X-Stream Air, h – 4,5 cm
3. Porolonas
4. 7 minkštumo zonų „multipocket“ kišeninės spyruoklės, h – 15 cm
5. Didelio elastingumo porolonas HR - 35 kg/m³, h – 3cm



Mattress with 7 firmness zones pocket springs, h – 25 cm

1. Mattress cover quilted with 200 g PES
2. Latex X-Stream Air, h – 4,5 cm
3. Foam
4. 7 firmness zones „multipocket“ springs, h – 15 cm
5. High-resilience foam HR - 35 kg/m³, h – 3cm

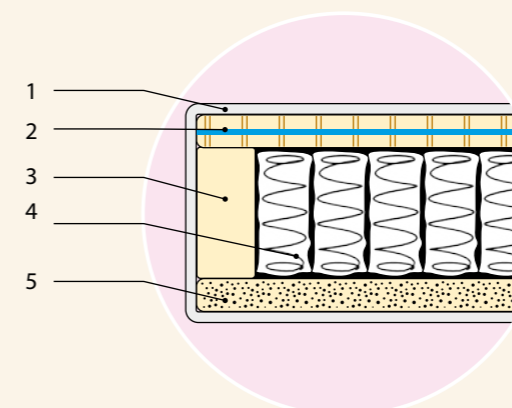

SILVA Visko



Čiužinys su 7 minkštumo zonų kišeninėmis spyruoklėmis, h – 25 cm

1. Čiužinio užvalkalas, daigstytas su 200 g PES
2. Viskoelastinis porolonas VE - 50 kg/m³, h – 4 cm
3. Porolonas
4. 7 minkštumo zonų „multipocket“ kišeninės spyruoklės, h – 15 cm
5. Didelio elastingumo porolonas HR - 35 kg/m³, h – 4 cm



Mattress with 7 firmness zones pocket springs, h – 25 cm

1. Mattress cover quilted with 200 g PES
2. Visco foam VE - 50 kg/m³, h – 4 cm
3. Foam
4. 7 firmness zones „multipocket“ springs, h – 15 cm
5. High-resilience foam HR - 35 kg/m³, h – 4 cm

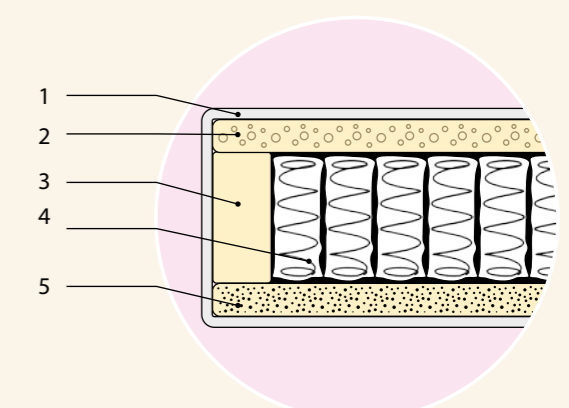



BANGA Visko



Čiužinys su 5 minkštumo zonų kišeninėmis spyruoklėmis, h – 22 cm

1. Čiužinio užvalkalas, daigstytas su 200 g PES
2. Viskoelastinis porolonas VE - 50 kg/m³, h – 4 cm
3. Porolonas
4. 5 minkštumo zonų kišeninės spyruoklės, h – 13 cm
5. Porolonas T - 25 kg/m³, h – 4 cm



Mattress with 5 firmness zones pocket springs, h – 22 cm

1. Mattress cover quilted with 200 g PES
2. Visco foam VE - 50 kg/m³, h – 4 cm
3. Foam
4. 5 firmness zones pocket springs, h – 13 cm
5. Foam T - 25 kg/m³, h – 4 cm

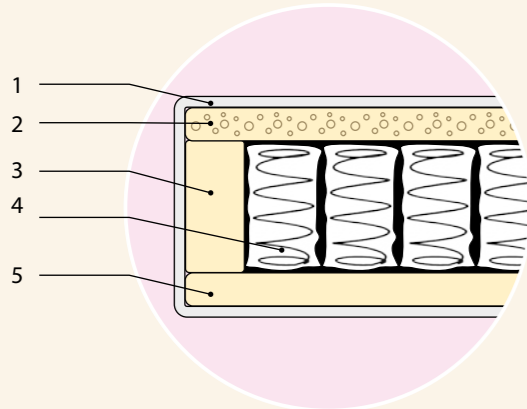

BANGA HR



Čiužinys su 5 minkštumo zonų kišeninėmis spyruoklėmis, h – 22 cm

1. Čiužinio užvalkalas, daigstytas su 200 g PES
2. Didelio elastingumo porolonas HR - 35 kg/m³, h – 4 cm
3. Porolonas
4. 5 minkštumo zonų kišeninės spyruoklės, h – 13 cm



Mattress with 5 firmness zones pocket springs, h – 22 cm

1. Mattress cover quilted with 200 g PES
2. High-resilience foam HR - 35 kg/m³, h – 4 cm
3. Foam
4. 5 firmness zones pocket springs, h – 13 cm

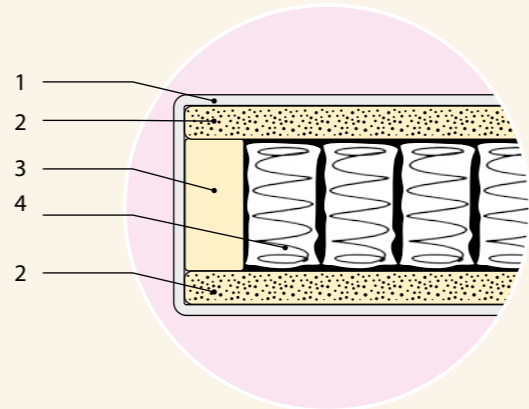

BANGA



Čiužinys su 5 minkštumo zonų kišeninėmis spyruoklėmis, h – 22 cm

1. Čiužinio užvalkalas, daigstytas su 200 g PES
2. Porolonas T - 25 kg/m³, h – 4 cm
3. Porolonas
4. 5 minkštumo zonų kišeninės spyruoklės, h – 13 cm



Mattress with 5 firmness zones pocket springs, h – 22 cm

1. Mattress cover quilted with 200 g PES
2. Foam T - 25 kg/m³, h – 4 cm
3. Foam
4. 5 firmness zones pocket springs, h – 13 cm

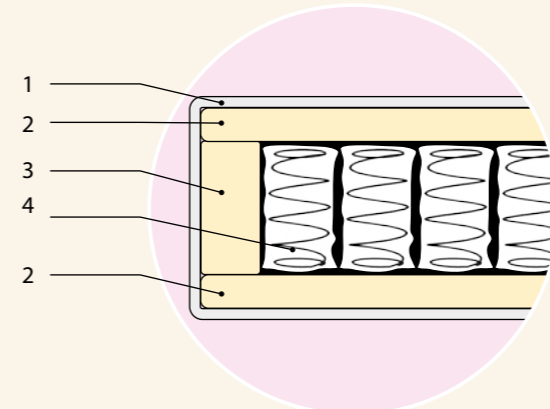

IEVA HR



Čiužinys su Bonnell tipo spyruoklėmis, h – 18 cm

1. Čiužinio užvalkalas, daigstytas su 200 g PES
2. Didelio elastingumo porolonas HR - 35 kg/m³, h – 2 cm
3. Neaustinė kaitytinė medžiaga
4. Porolonas
5. Bonnell spyruoklės, h – 12 cm



Mattress with Bonnell springs, h – 18 cm

1. Mattress cover quilted with 200 g PES
2. High-resilience foam HR - 35 kg/m³, h – 2 cm
3. Non-woven caulked material
4. Foam
5. Bonnell springs, h – 12 cm

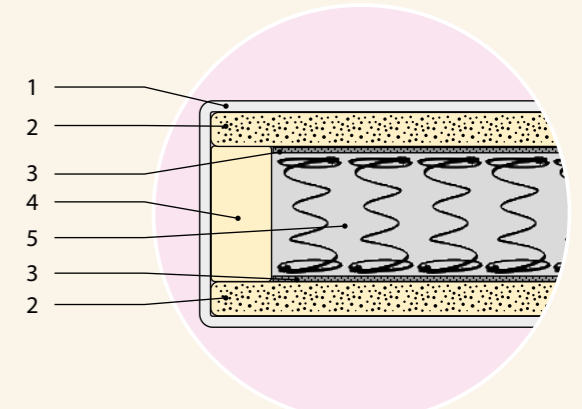

IEVA



Čiužinys su Bonnell tipo spyruoklėmis, h – 18 cm

1. Čiužinio užvalkalas, daigstytas su 100 g PES
2. Porolonas T - 25 kg/m³, h – 2 cm
3. Neaustinė kaišytinė medžiaga
4. Porolonas
5. Bonnell spyruoklės, h – 12 cm



Mattress with Bonnell springs, h – 18 cm

1. Mattress cover quilted with 100 g PES
2. Foam T - 25 kg/m³, h – 2 cm
3. Non-woven caulked material
4. Foam
5. Bonnell springs, h – 12 cm



ŪLA



Čiužinys su porolonu, h – 12 cm

1. Čiužinio užvalkalas, daigstytas su 200 g PES
2. Porolonas T-25 kg/m³, h – 10 cm



Foam mattress, h – 12 cm

1. Mattress cover quilted with 200 g PES
2. Foam T-25 kg/m³, h – 10 cm

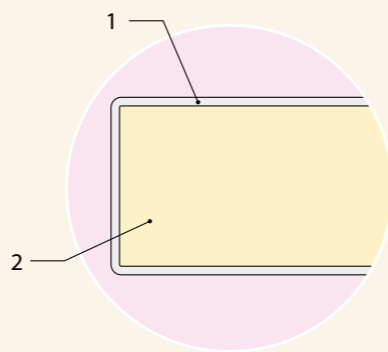
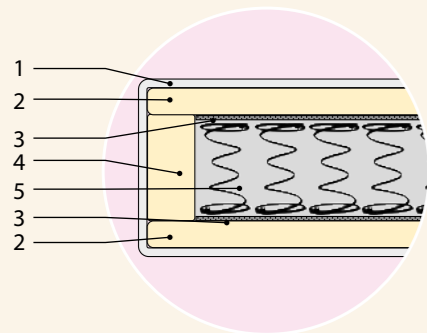

Turime galimybę rulonuoti ir sumažinti tūrį:

- Bonnell tipo čiužinių;
- Pocket tipo čiužinių;
- Porolono čiužinių ir antčiužinių.

Privalumai:

- Galimybė iki 70% padidinti pakraunamos produkcijos kiekį;
- Taupoma vieta sandėliuojant;
- Patogesnis čiužinio transportavimas į galutinio kliento namus.

We have possibility to roll and reduce volume of:

- Bonnell spring mattresses;
- Pocket spring mattresses;
- Foam mattresses and top-mattresses.

Advantages:

- Possibility to increase loaded production volume up to 70%;
- Saved space in warehouse;
- More convenient mattress transportation to final customer's home.

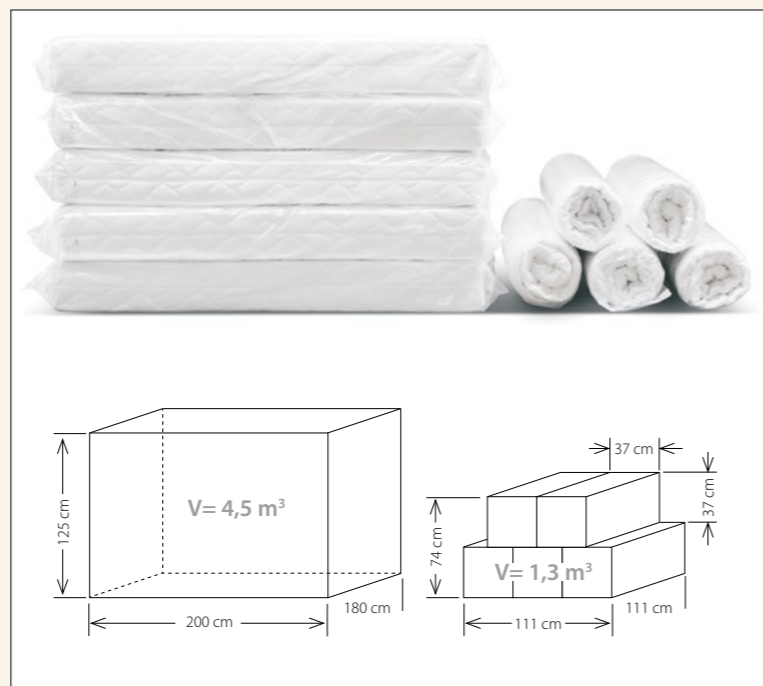

PRATO HR



Higieninis čiužinys, h – 7 cm

Didelio elastingumo profiliuotas porolonas HR - 35 kg/m³, h – 5 cm
Užvalkalas daigstytas su 200 g PES



Top-mattress, h – 7 cm

High-resilience profiled foam
HR - 35 kg/m³, h – 5 cm
Cover quilted with 200 g PES

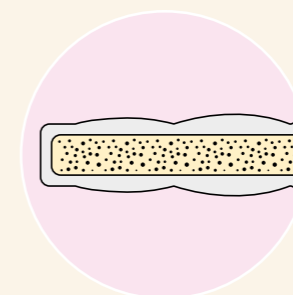

PRATO



Higieninis čiužinys, h – 7 cm

Profiluotas porolonas
T - 25 kg/m³, h – 5 cm
Užvalkalas daigstytas su 200 g PES



Top-mattress, h – 7 cm

Profiled foam T - 25 kg/m³, h – 5 cm
Cover quilted with 200 g PES

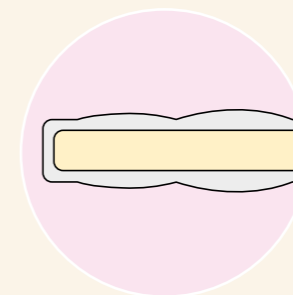



TOP Latex



Higieninis čiužinys, h – 6 cm
Lateksas, h – 4 cm
Užvalkalas daigstytas su 200 g PES



Top-mattress, h – 6 cm
Latex, h – 4 cm
Cover quilted with 200 g PES

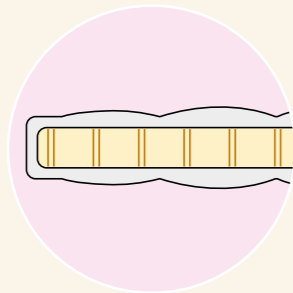

TOP Visko



Higieninis čiužinys, h – 6 cm
Viskoelastinis porolonas
VE - 50 kg/m³, h – 4 cm
Užvalkalas daigstytas su 200 g PES



Top-mattress, h – 6 cm
Visco foam VE - 50 kg/m³, h – 4 cm
Cover quilted with 200 g PES

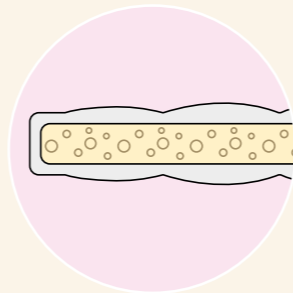

TOP HR



Higieninis čiužinys, h – 6 cm
Didelio elastingumo porolonas
HR - 35 kg/m³, h – 4 cm
Užvalkalas daigstytas su 200 g PES



Top-mattress, h – 6 cm
High-resilience foam HR - 35 kg/m³, h – 4 cm
Cover quilted with 200 g PES

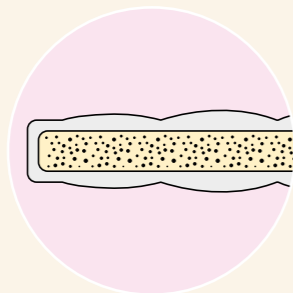

TOP



Higieninis čiužinys, h – 6 cm
Porolonas T - 25 kg/m³, h – 4 cm
Užvalkalas daigstytas su 200 g PES



Top-mattress, h – 6 cm
Foam T - 25 kg/m³, h – 4 cm
Cover quilted with 200 g PES

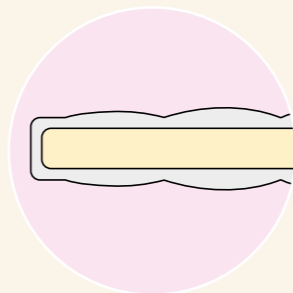

DOUBLE



Higieninis čiužinys su sagomis, intarpu ir dekoratyvine juosta, h – 6 cm
Didelio elastingumo porolonas HR - 35 kg/m³, h – 4 cm
Užvalkalas daigstytas su 300 g PES



Top-mattress with buttons, insert and piping, h – 6 cm
High-resilience foam HR - 35 kg/m³, h – 4 cm
Cover quilted with 300 g PES

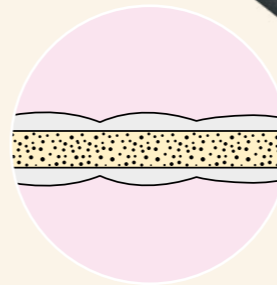

CONTINENTAL



Higieninis čiužinys su sagomis ir intarpu, h – 6 cm
Didelio elastingumo porolonas HR - 35 kg/m³, h – 4 cm
Užvalkalas daigstytas su 300 g PES



Top-mattress with buttons and insert, h – 6 cm
High-resilience foam HR - 35 kg/m³, h – 4 cm
Cover quilted with 300 g PES

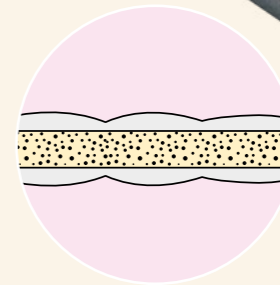
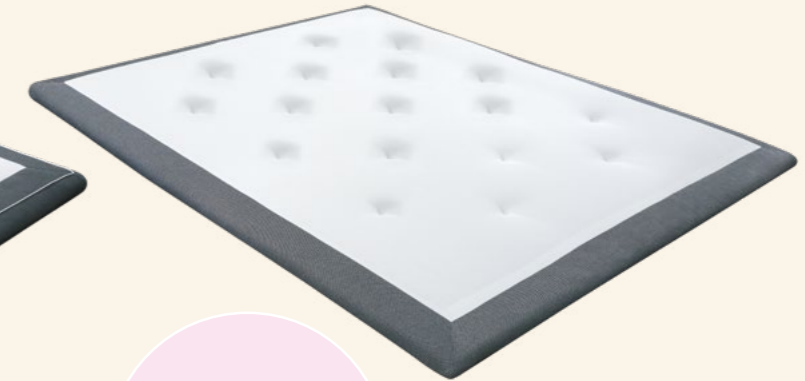

KENTUCKY



Higieninis čiužinys su sagomis, su skeltu; h – 8 cm
Viskoelastinis porolonas VE - 50 kg/m³, h – 5 cm
Užvalkalas daigstytas su 450 g PES



Top-mattress with buttons, with single split; h – 8 cm
Visco foam VE - 50 kg/m³, h – 5 cm
Cover quilted with 450 g PES

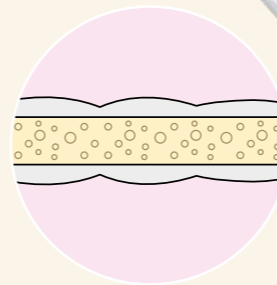

ROYAL BASIC



Higieninis čiužinys su 2 skeltais; h – 7 cm
Porolonas T - 25 kg/m³, h – 5 cm
Užvalkalas daigstytas su 200 g PES



Top-mattress with double split; h – 7 cm
Foam T - 25 kg/m³, h – 5 cm
Cover quilted with 200 g PES

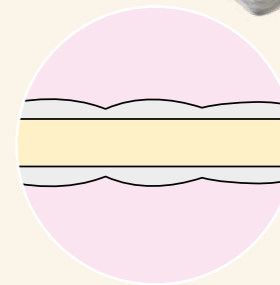



HELSINKI



Higieninis čiužinys, h – 8 cm
Viskoelastinis porolonas VE - 50 kg/m³, h – 5 cm
Užvalkalas daigstytas su 300 g PES



Top-mattress, h – 8 cm
Visco foam VE - 50 kg/m³, h – 5 cm
Cover quilted with 300 g PES

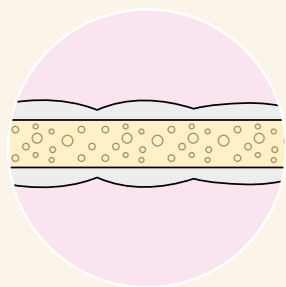

VEGAS



Higieninis čiužinys, h – 8 cm
Lateksas, h – 4 cm
Užvalkalas daigstytas su 650 g PES



Top-mattress, h – 8 cm
Latex, h – 4 cm
Cover quilted with 650 g PES

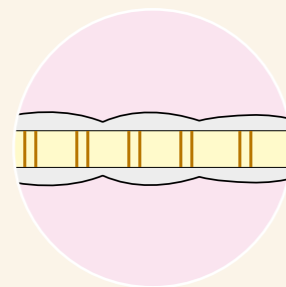

X-STREAM AIR



Higieninis čiužinys, h – 11 cm
Lateksas X-Stream Air, h – 4,5 cm x 2
Užvalkalas daigstytas su 200 g PES



Top-mattress, h – 11 cm
Latex X-Stream Air, h – 4,5 cm x 2
Cover quilted with 200 g PES

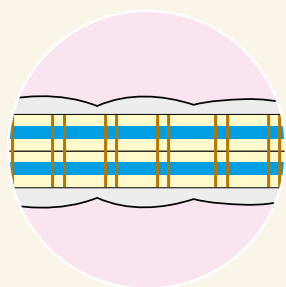

MAUD/SUOMI



Higieninis čiužinys, h – 10 cm
Porolonas T - 25 kg/m³, h – 7 cm
Užvalkalas daigstytas su 300 g PES



Top-mattress, h – 10 cm
Foam T - 25 kg/m³, h – 7 cm
Cover quilted with 300 g PES

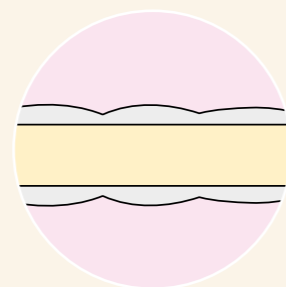

GEL



Higieninis čiužinys, h – 6 cm
Lateksas su želė gabaliukais GEL INFUSED, h – 4 cm
Užvalkalas daigstytas su 200 g PES



Top-mattress, h – 6 cm
GEL INFUSED latex, h – 4 cm
Cover quilted with 200 g PES

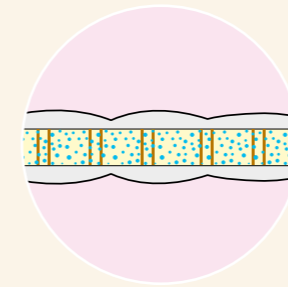

VISCO - GEL



Higieninis čiužinys, h – 10 cm
Visko lateksas RESHAPE, h – 4 cm + lateksas su želė gabaliukais GEL INFUSED, h – 4 cm
Užvalkalas daigstytas su 200 g PES



Top-mattress, h – 10 cm
Visco latex RESHAPE, h – 4 cm + GEL INFUSED latex, h – 4 cm
Cover quilted with 200 g PES

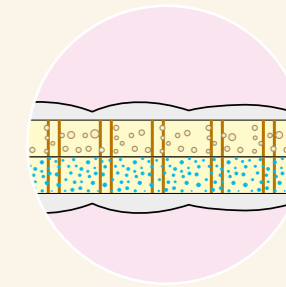

DREAM



Higieninis čiužinys, h – 8 cm
Didelio elastingumo porolonas HR - 35 kg/m³, h – 6 cm
Užvalkalas daigstytas su 1 cm viskoelastiniu porolonu



Top-mattress, h – 8 cm
High-resilience foam HR - 35 kg/m³, h – 6 cm
Cover quilted with 1 cm visco foam

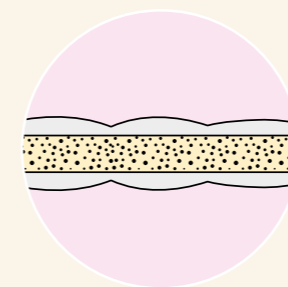

PROXIMA



Higieninis čiužinys, h – 11 cm
Porolonas T - 30 kg/m³, h – 3 cm;
mikrokišenių spyruoklių blokas, h – 3 cm; lateksas, h – 2 cm
Užvalkalas daigstytas su 300 g PES



Top-mattress, h – 11 cm
Foam T - 30 kg/m³, h – 3 cm; micro pocket springs, h – 3 cm; latex, h – 2 cm
Cover quilted with 300 g PES

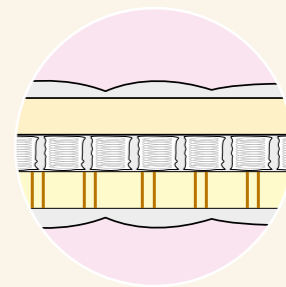

HAMAR

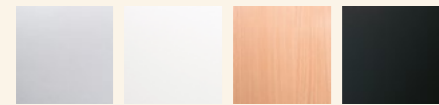

 Išmatavimai: 58 x 51 x 36
 Rėmas: LMD plokštė
 Stalčių skaičius: 3
 Galimos spalvos: sidabrinė, balta, natūrali, juoda
 Šonų audinys: pagal pasirinkimą

 Dimensions: 58 x 51 x 36
 Frame: laminated chipboard
 Drawers quantity: 3
 Available colours: silver, white, natural, black
 Sides fabric: according to your choice



OSLO

 Išmatavimai: 51 x 49 x 36
 Rėmas: LMD plokštė
 Stalčių skaičius: 2
 Galimos spalvos: sidabrinė, balta, natūrali, juoda
 Šonų audinys: pagal pasirinkimą

 Dimensions: 51 x 49 x 36
 Frame: laminated chipboard
 Drawers quantity: 2
 Available colours: silver, white, natural, black
 Sides fabric: according to your choice



VALENCIA



 Išmatavimai: 45 x 45 x 50
 Rėmas: MDP plokštė

 Dimensions: 45 x 45 x 50
 Frame: chipboard



MADRID



 Išmatavimai: 45 x 45 x 50
 Rėmas: LMD plokštė
 Viršus: stiklas

 Dimensions: 45 x 45 x 50
 Frame: laminated chipboard
 Top: glass



ROMA



 Išmatavimai: 57 x 50 x 40
 Rėmas: LMD plokštė
 Stalčių skaičius: 3
 Viršus: stiklas

 Dimensions: 57 x 50 x 40
 Frame: laminated chipboard
 Drawers quantity: 3
 Top: glass



PALMA



 Išmatavimai: 43 x 44 x 50
 Rėmas: LMD plokštė
 Viršus: stiklas

 Dimensions: 43 x 44 x 50
 Frame: laminated chipboard
 Top: glass



LEON

 Išmatavimai: 50 x 45 x 50 cm
 Rėmas: LMD plokštė
 Stalčių skaičius: 1

 Dimensions: 50 x 45 x 50 cm
 Frame: laminated chipboard
 Drawers quantity: 1



HAKU

 Išmatavimai: 50 x 45 x 50
 Rėmas: MDP

 Dimensions: 50 x 45 x 50
 Frame: chipboard



PUFAI / POUFS

PUFAI SU ĮVAIRIŲ DIZAINŲ DANGČIAIS / POUFS WITH DIFFERENT DESIGN LIDS



Išmatavimai: 51 x 40 x 100/120/140/160/180
Rėmas: LMD plokštė
Viršus: atidaromas dangtis



Dimensions: 51 x 40 x 100/120/140/160/180
Frame: laminated chipboard
Top: open lid



ASPEN



Išmatavimai: 115 x 45 x 40
Rėmas: MDP



Dimensions: 115 x 45 x 40
Frame: chipboard



KOJELĖS / LEGS



ELZA



- Pagalvė 45 x 65 cm
- Užpildas: Porolono gabalėliai (83%), PES granulės (17%)
- Užvalkalas daigstytas su 200 g PES
- Užpildo svoris: 600 g



- Pillow 45 x 65 cm
- Filling: Shredded foam (83%), Grains of PES (17%)
- Cover quilted with 200 g PES
- Filling weight: 600 g



PAULA



- Pagalvė 45 x 65 cm
- Užpildas: Viskoelastinio porolono gabalėliai (100%)
- Užvalkalas daigstytas su 1 cm viskoelastinio porolono
- Užpildo svoris: 1000 g / 1200 g



- Pillow 45 x 65 cm
- Filling: 100% of shredded viscoelastic foam
- Cover quilted with 1 cm viscoelastic foam
- Filling weight: 1000 g / 1200 g



ALFA



- Pagalvė 40 x 60 cm / 50 x 70 cm
- Užpildas: Viskoelastinio porolono gabalėliai (100%)
- Užvalkalas daigstytas su 1 cm viskoelastinio porolono
- Užpildo svoris: 1100 g / 1500 g



- Pillow 40 x 60 cm / 50 x 70 cm
- Filling: 100% of shredded viscoelastic foam
- Cover quilted with 1 cm viscoelastic foam
- Filling weight: 1100 g / 1500 g



MAXI



- Pagalvė 50 x 70 cm
- Užpildas: Porolono gabalėliai (83%), PES granulės (17%)



- Pillow 50 x 70 cm
- Filling: Shredded foam (83%), Grains of PES (17%)



ISABELA



- Pagalvė 70 x 70 cm / 60 x 60 cm / 65 x 45 cm
- Užpildas: Porolono gabalėliai (83%), PES granulės (17%)



- Pillow 70 x 70 cm / 60 x 60 cm / 65 x 45 cm
- Filling: Shredded foam (83%), Grains of PES (17%)



VICTORIA



- Pagalvė 50 x 70 cm
- Užpildas: Porolono gabalėliai (83%), PES granulės (17%)



- Pillow 50 x 70 cm
- Filling: Shredded foam (83%), Grains of PES (17%)



ANNA



- Pagalvė 50 x 50 cm / 50 x 70 cm
- Užpildas: Porolono gabalėliai (83%), PES granulės (17%)



- Pillow 50 x 50 cm / 50 x 70 cm
- Filling: Shredded foam (83%), Grains of PES (17%)



MIAMI



- Pagalvė 65/75/85 x 20 x 20 cm
- Užpildas: Porolono gabalėliai (83%), PES granulės (17%)



- Pillow 65/75/85 x 20 x 20 cm
- Filling: Shredded foam (83%), Grains of PES (17%)



Multi kišeninės spyruoklės Ø 43 mm
Vielos Ø 1,4 mm
Vijų skaičius: 9
Spyruoklės aukštis 125 - 150 mm
460 spyruoklių/m²



Multi pocket spring's Ø 43 mm
Wire's Ø 1,4 mm
Number of strands: 9
Spring height 125 - 150 mm
460 springs/m²

Kišeninės spyruoklės Ø 63 mm
Vielos Ø 1,8 mm
Vijų skaičius: 6
Spyruoklės aukštis 125 - 150 mm
270 spyruoklių/m²



Pocket spring's Ø 63 mm
Wire's Ø 1,8 mm
Number of strands: 6
Spring height 125 - 150 mm
270 springs/m²

Multi kišeninės spyruoklės - korys Ø 43 mm
Vielos Ø 1,4 mm
Vijų skaičius: 8
Spyruoklės aukštis 125 - 150 mm
580 spyruoklių/m²



Multi pocket nested spring's Ø 43 mm
Wire's Ø 1,4 mm
Number of strands: 8
Spring height 125 - 150 mm
580 springs/m²

Kišeninės spyruoklės - korys Ø 63 mm
Vielos Ø 1,8 mm
Vijų skaičius: 6
Spyruoklės aukštis 125 - 150 mm
330 spyruoklių/m²



Nested pocket spring's Ø 63 mm
Wire's Ø 1,8 mm
Number of strands: 6
Spring height 125 - 150 mm
330 springs/m²

Kišeninės spyruoklės Ø 63 mm su metaliniu rėmeliu
Vielos Ø 1,8 mm
Vijų skaičius: 6
Spyruoklės aukštis 125 - 150 mm
270 spyruoklių/m²



Pocket spring's Ø 63 mm with metal frame
Wire's Ø 1,8 mm
Number of strands: 6
Spring height 125 - 150 mm
270 springs/m²

Bonnell spyruoklės Ø 87 mm
Vielos Ø 2,2 mm
Vijų skaičius: 4 - 5
Spyruoklės aukštis 100 - 125 mm
130 spyruoklių/m²



Bonnell spring's Ø 87 mm
Wire's Ø 2,2 mm
Number of strands: 4 - 5
Spring height 100 - 125 mm
130 springs/m²

Bonnell spyruoklės Ø 87 mm su metaliniu rėmeliu
Vielos Ø 2,2 mm
Vijų skaičius: 4 - 5
Spyruoklės aukštis 100 - 125 mm
130 spyruoklių/m²

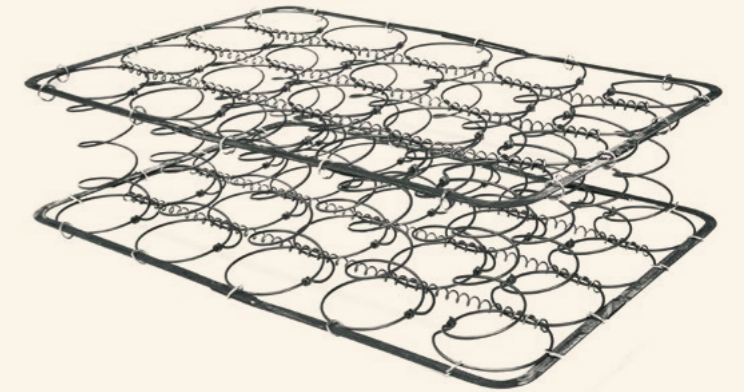

Bonnell spring's Ø 87 mm with metal frame
Wire's Ø 2,2 mm
Number of strands: 4 - 5
Spring height 100 - 125 mm
130 springs/m²

Parduodame kišeninių ir bonnell tipo spyruoklių blokus, kuriuos sandėliavimo ir transportavimo patogumui rulnuojame. Rulone gali būti 5 - 10 spyruoklių bloku.

We sell pocket and bonnell springs' blocks that we roll for storing and transportation efficiency. In one roll there can be 5 - 10 spring blocks.

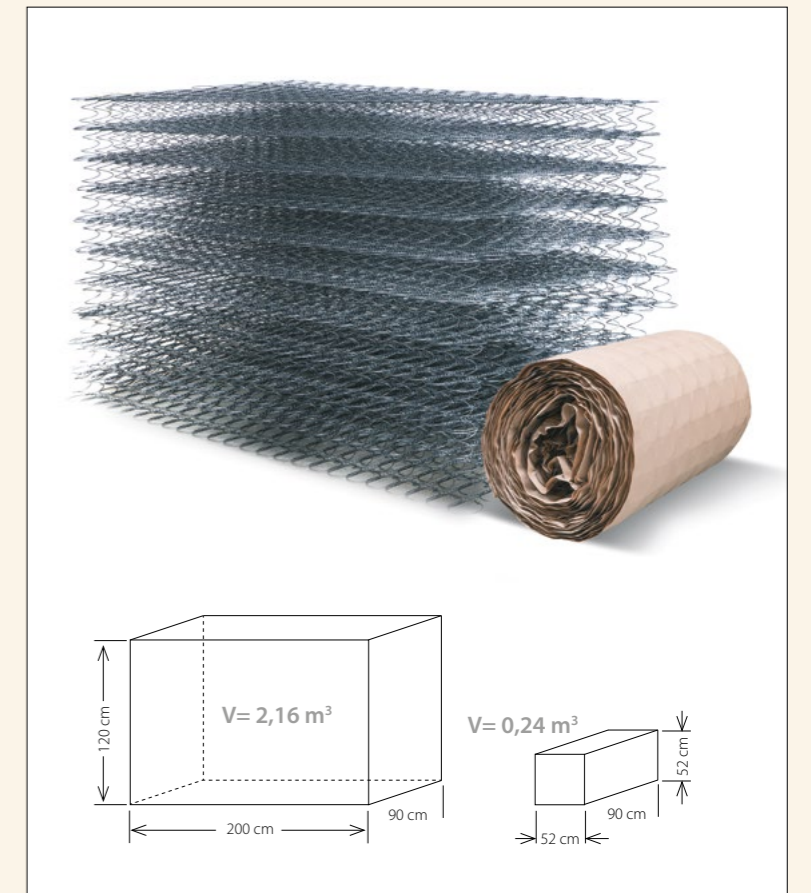



Gaminame smulkintą poroloną ir visko elastingą poroloną.

Smulkinto porolono granulės – specialia įranga sukapotos porolono dalelės, naudojamos kaip užpildas pagalvėms, antklodėms, pakavimui ir kt. Siūlome įvairaus dydžio granules.



We produce schreded foam and viscoelastic foam.

Schreded foam granules – with special equipment cut foam pieces that could be used as filling for pillows, blankets, packing, etc. We offer different sizes granules.



Individuali Arvydo Padvaisko įmonė įkurta 1992 metais. 1996 metais įmonė buvo reorganizuota į uždaryją akcinę bendrovę.

Nuo 2002 metų UAB "Padvaiskas ir Ko" gamina produkciją pačia pažangiausia čiužinių surinkimo linija. Šios gamybinės linijos darbo našumas – per vieną minutę čiužinys pilnai pagaminamas ir supakuojamas.

2014 metais įsigytos Japoniškos kišeninių spyruoklių gamybos staklės leidžia gaminti įvairiausio minkštumo/kietumo spyruoklinius blokus. Su vieno storio viela galime išgauti įvairaus minkštumo/kietumo spyruokles – taip iš jų suformuojami skirtingų komforto zonų spyruokliniai blokai čiužiniams ir lovoms.

2015 metais atidarytas porolono pjaustymo padalinys.

Įmonės išskirtinumas – gebėjimas greitai prisitaikyti prie kiekvieno pirkėjo! Įmonė pasižymi gamybos lankstumu, nes visos lovų dalys ir žaliavos gaminamos vietoje – mediniai rėmai, lovų karkasai, MDP dėžės, „Bonnell“ ir „kišeninės /begarsės“ spyruoklės, galvūgaliai, siuvami užvalkalai, daigstomi audiniai, supjaujami porolonas.

UAB „Padvaiskas ir Ko“ kasmet modernizuoja ir plečia gamybą. Po 2018 m. pastatų rekonstrukcijos gamybiniai plotai siekia 21 500 m².

2017 m. įsigyti įrengimai ir čiužinių „rulonavimui“ - pagamintas čiužinys standžiai susukamas ir iškart supakuojamas.

Įmonė plečiasi bendradarbiaudama su klientais bei partneriais iš visos Europos, Skandinavijos, Turkijos. Šiandien virš 98 procentų produkcijos eksportuojame į Olandiją, Belgiją, Vokietiją, Daniją, Norvegiją, Suomiją, Švediją, Prancūziją, Islandiją, Liuksemburgą, Austriją, Šveicariją. Gaminame virš 60 rūšių - klasikinio, šiuolaikinio ir modernaus dizaino čiužinių bei lovų. Gamyboje naudojame tik aukščiausios kokybės medžiagas, pripažintas ir sertifikuotas Europos Sąjungoje.



Individual Arvydas Padvaiskas enterprise was established in 1992. In 1996 enterprise was reorganized to Joint - stock company.

Since 2002 JSC "Padvaiskas & Ko" has been producing using the most advanced mattresses assembly line. Productivity of this production line allows to fully produce and pack one mattress per one minute.

Japanese pocket springs machine, purchased in 2014, allows us to produce a variety of spring blocks in different hardness. Using just one diameter of wire, we can produce different hardness springs – from them are produced spring blocks with different comfort zones for mattress and beds.

In 2015 new unit of foam cutting was opened.

The company's uniqueness is the ability to adapt quickly to every buyer! The company is characterized by flexibility of production, because all parts of the beds and raw materials are made on the spot - wooden frames, bed frames, MDP boxes, bonnell and pocket (silent springs), headboards, covers sewing, fabrics quilting and foam cutting.

JSC "Padvaiskas & Ko" annually modernizes and expands production. After 2018 reconstruction production area is 21 500 m².

Mattresses rolling machine, purchased in 2017, allows us to vacuum, roll and pack all kind of mattresses.

The company is expanding in cooperation with its customers and partners from all over Europe, Scandinavia and Turkey. Today we are exporting over 98% of our production to Netherlands, Belgium, Germany, Denmark, Norway, Finland, Sweden, France, Iceland, Luxembourg, Austria, Switzerland. We are producing over 60 types classic, contemporary and modern design mattresses and beds. We use only the highest quality materials that are recognized and certified in the European Union.

KATALOGO SUTARTINIAI ŽENKLAI / CATALOG LEGEND

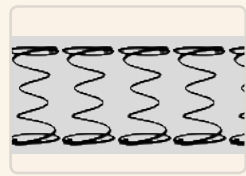

Bonnell spyruoklės
Bonnell springs

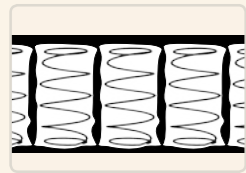

Kišeninės spyruoklės
Pocket springs

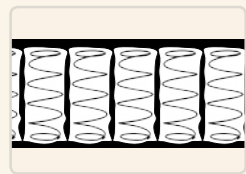

„Multipocket“ kišeninės spyruoklės
„Multipocket“ springs



Porolonas
Foam

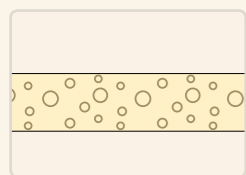

Viskoelastinis porolonas
Visco foam

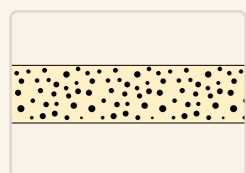

Didelio elastingumo porolonas
High-resilience foam

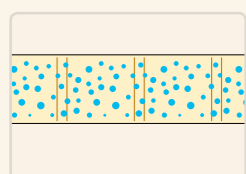

Lateksas su želė gabaliukais
GEL INFUSED
GEL INFUSED LATEX



Lateksas
Latex

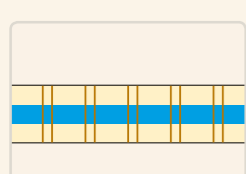

Lateksas, X-streem
Latex, X-streem

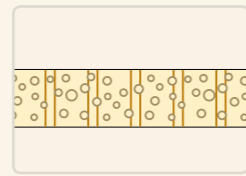

Lateksas RESHAPE
Latex RESHAPE

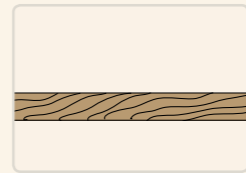

Medinis rėmas
Wooden frame

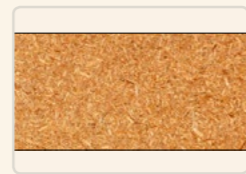

MDP
Chipboard

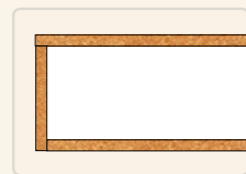

LMDP
Laminated chipboard

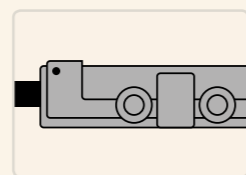

Metalinis rėmas su varikliu
Metal frame with motor

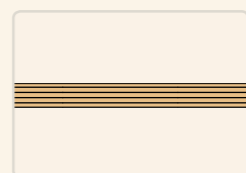

Fanera
Plywood

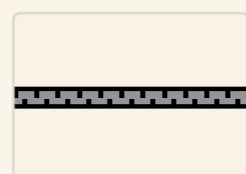

Neaustinė kaišytinė medžiaga
Non - woven caulked material

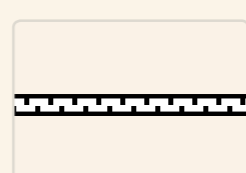

Neaustinė medžiaga - sponbondas
Non - woven material - sponbond



SKANDIMĒBELES
SKANDINĀVU DIZAINA MĒBEĻU SALONS

ieskaties mūsu mājaslapā
www.skandimebeles.lv